

TOSHIBA

Leading Innovation >>>

NETWORK CAMERA

Model: IK-WD12A

User's Manual

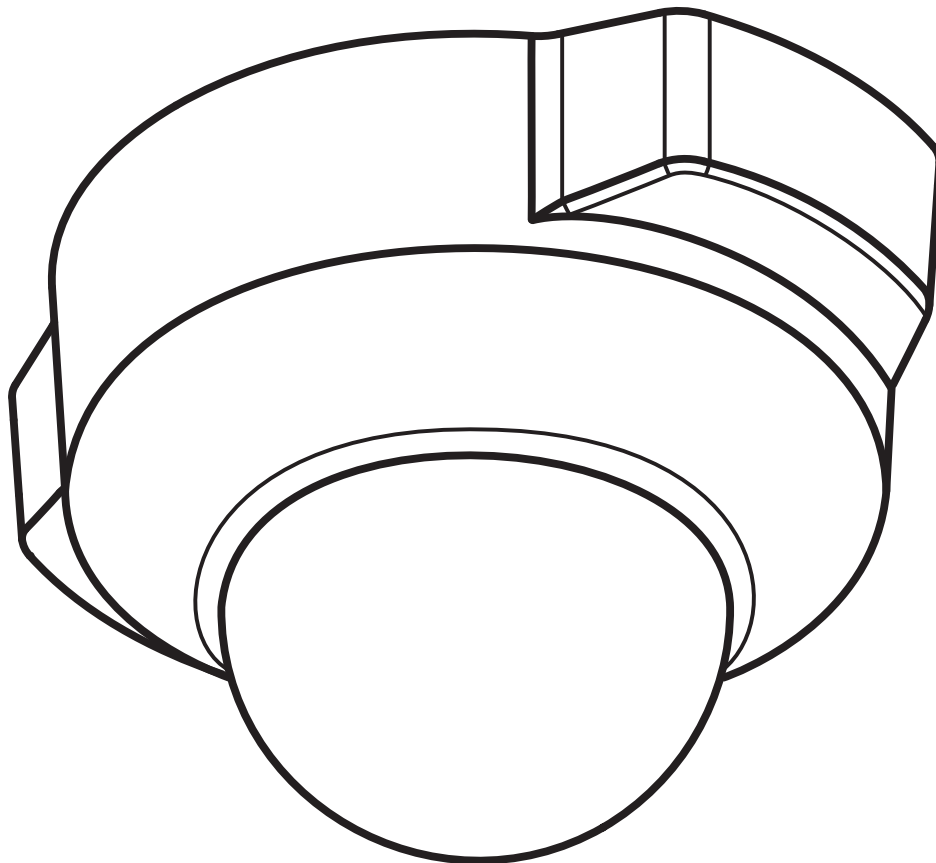

For information on our latest products and peripheral devices, refer to the following Website:

■ <http://www.toshibasecurity.com>

If the URL changes, refer to the Toshiba website (<http://www.toshiba.com/>).

Table of Contents

<i>Introduction</i>	4
<i>Important Safeguards</i>	6
<i>Important Safeguards (Cont.)</i>	8
<i>Notes on Use and Installation</i>	9
<i>Precautions for Use</i>	10
<i>AC Adapter</i>	11
<i>Package Contents</i>	13
<i>Physical Description</i>	14
<i>Installation</i>	18
Hardware Installation.....	18
Network Deployment.....	18
Software Installation.....	20
Ready to Use.....	21
<i>Accessing the Network Camera</i>	22
Using Web Browsers.....	22
Using RTSP Players.....	24
Using 3GPP-compatible Mobile Devices.....	25
<i>Main Page</i>	26
<i>Client Settings</i>	30
<i>Configuration</i>	32
System.....	33
Security.....	35
HTTPS (Hypertext Transfer Protocol over SSL).....	36
SNMP (Simple Network Management Protocol).....	41
Network.....	42
DDNS.....	57
Access List.....	58
Audio and Video.....	61
Motion Detection.....	74
Camera Tampering Detection.....	77
Camera Control.....	78
Homepage Layout.....	82
Application.....	85
Recording.....	98
Local Storage.....	101
System Log.....	105
View Parameters.....	105
Maintenance.....	106
<i>Troubleshooting</i>	110

<i>Troubleshooting</i>	110
Reboot and restore.....	110
Audio	110
External Microphone	110
Day / Night setting	110
Recommended system requirements.....	110
<i>Specifications</i>	111
<i>Appearance Diagram</i>	113
<i>Technology License Notice</i>	114
<i>End-user License Agreement on Free Software Components Used in the TOSHIBA Network Camera</i>	115

FCC (USA)-INFORMATION

NOTE: This equipment has been tested and found to comply with the limits for a Class B digital device, pursuant to Part 15 of the FCC Rules. These limits are designed to provide reasonable protection against harmful interference in a residential installation. This equipment generates, uses and can radiate radio frequency energy and, if not installed and used in accordance with the instructions, may cause harmful interference to radio communications. However, there is no guarantee that interference will not occur in a particular installation. If this equipment does cause harmful interference to radio or television reception, which can be determined by turning the equipment off and on, the user is encouraged to try to correct the interference by one or more of the following measures:

- Reorient or relocate the receiving antenna.
 - Increase the separation between the equipment and receiver.
 - Connect the equipment into an outlet on a circuit different from that to which the receiver is connected.
 - Consult the dealer or an experienced radio/TV technician for help.
- Shielded interface cables must be used in order to comply with emission limits.

USER-INSTALLER CAUTION: Your authority to operate this FCC verified equipment could be voided if you make changes or modifications not expressly approved by the party.

Thank you for purchasing the IK-WD12A Network Camera. Before you start using the camera, read this User's Manual carefully to ensure correct usage. Once you have finished reading this User's Manual, keep it in a convenient place for future reference.

The design, specifications, software, and User's Manual contents are subject to change without prior notice.

Terms and Trademarks

- The term "OS" is used in this manual to indicate operating systems compatible with this product.
 - Windows® XP: Microsoft® Windows® XP operating system
 - Windows Vista®: Microsoft® Windows Vista® Business operating system
 - Windows 7®: Microsoft® Windows 7® Professional operating system
- The formal name of Windows® is Microsoft® Windows® Operating System.
- Microsoft®, Windows® and Windows Vista® are trademarks or registered trademarks of Microsoft® Corporation in the United States and other countries.
- Adobe® is a registered trademark and Adobe Reader® is a trademark of Adobe Systems Incorporated.
- Other product names appearing in this quick start guide may be trademarks or registered trademarks of their respective holders.

NOTE

- The performance of the network camera may vary depending on the network environment.
- When using multiple network cameras, the appropriate network switch and PC are required.
- This camera does not support MAC-PC.

Important Safeguards

1. Read Instructions

Read all the safety and operating instructions before operating the product.

2. Retain Instructions

Retain the safety instructions and user's manual for future reference.

3. Warnings

Comply with all warnings on the product and in the user's manual.

4. Follow Instructions

Follow all operating and use instructions.

5. Cleaning

Disconnect this camera from the power supply before cleaning.

6. Attachments

Do not use attachments not recommended by the camera manufacturer as they may pose safety risks.

7. Water and Moisture

Do not use this camera near water. Some examples are: near a bath tub, wash bowl, kitchen sink, or laundry tub, in a wet basement, or near a swimming pool.

8. Accessories

Do not place this camera on an unstable cart, stand, tripod, bracket or table. The camera may fall, causing serious injury to a person, or serious damage to the product. Use only with stand, tripod, bracket, or table recommended by the manufacturer, or sold with the camera. Any mounting of the product should follow the manufacturer's instructions, and should use a mounting accessory recommended by the manufacturer.

9. Ventilation

This camera should never be placed near or over a radiator or heat register. If this product is placed in a built in installation verify that there is proper ventilation so that the camera temperature operates within the recommended temperature range.

10. Power Sources

This camera should be operated only from the type of power source indicated on the information label. If you are not sure of the type of power supply at your location, consult your product dealer.

11. Power-Cord Protection

Power cords should be routed so that they are not likely to be walked on or pinched by items placed upon or against them. Pay particular attention to cords at plugs, screws and the point where they exit the product.

12. Installation

Install this camera on a secure part of the ceiling or wall. If installed on an unsecured location, the camera could fall causing injury and damage.

13. Lightning

For additional protection on this camera during a lightning storm, or when it is left unattended and unused for long periods of time, unplug it from the wall outlet and disconnect the power supply and cable system. This will prevent damage to the camera due to lightning and power-line surges. If lightning occurs, do not touch the unit or any connected cables in order to avoid electric shock.

14. Overloading

Do not overload the power supply or extension cords as this can result in a risk of fire or electric shock.

15. Object and Liquid Entry

Never push objects of any kind into this camera through openings as they may touch dangerous electrical points or short-out parts that could result in a fire or electrical shock. Never intentionally spill liquid of any kind on the camera.

16. Servicing

Do not attempt to service this camera yourself as opening or removing covers may expose you to dangerous electrical or other hazards. Refer all servicing to qualified service personnel.

17. Damage Requiring Service

Disconnect this camera from the power supply and refer servicing to qualified service personnel under the following conditions.

- a. When the power-supply cord or plug is damaged.
- b. If liquid has been spilled, or objects have fallen into the camera.
- c. If the camera has been submerged in water.
- d. If the camera does not operate normally by following the operating instructions in the user's manual. Adjust only those controls that are covered by the user's manual as an improper adjustment of other controls may result in damage and will often require extensive work by a qualified technician to restore the camera to its normal operation.
- e. If the camera has been dropped or the cabinet has been damaged.
- f. When the camera exhibiting a distinct change in performance which indicates a need for service.
- g. Other trouble.

18. Replacement Parts

When replacing parts be sure the service technician uses parts specified by the manufacturer or have the same characteristics as the original part. Unauthorized substitutions may result in fire, electric shock or other hazards.

19. Safety Check

Upon completion of any service or repairs to this camera, ask the service technician to perform safety checks to determine that the camera is in proper operating condition.

Important Safeguards (Cont.)

CAUTION TO REDUCE THE RISK OF ELECTRIC SHOCK.

DO NOT REMOVE COVER. NO USER SERVICEABLE PARTS INSIDE. REFER SERVICING TO QUALIFIED SERVICE PERSONNEL.



The lightning flash with arrowhead symbol, within an equilateral triangle, is intended to alert the user to the presence of uninsulated "dangerous voltage" within the product's enclosure that may be of sufficient magnitude to constitute a risk of electric shock to persons.



The exclamation point within an equilateral triangle is intended to alert the user to the presence of important operating and maintenance (servicing) instructions in the literature accompanying the appliance.

WARNING:

TO REDUCE THE RISK OF FIRE OR ELECTRIC SHOCK, DO NOT EXPOSE THIS APPLIANCE TO RAIN OR MOISTURE.

FIELD INSTALLATION MARKING:

WORDED: "THIS INSTALLATION SHOULD BE MADE BY A QUALIFIED SERVICE PERSON AND SHOULD CONFORM TO ALL LOCAL CODES."



Notes on Use and Installation

- **Do not aim the camera at the sun**

Never aim the camera at the sun even with the camera power off.

- **Do not shoot intense light**

Intense light such as a spotlight may cause a bloom or smear. A vertical stripe may appear on the screen. However, this is not a malfunction.

- **Treat the camera with care**

Dropping or subjecting the camera to intense vibration may cause it to malfunction.

- **Avoid Volatile Liquid**

Do not use volatile liquids, such as an insect spray, near the unit. Do not leave rubber or plastic products touching the unit for a long time. They will leave marks on the finish. Do not use a chemically saturated cloth.

- **Never touch internal parts**

Do not touch the internal parts of the camera other than the parts specified.

- **Keep the camera installation away from video noise**

If cables are wired near electric lighting wires or a TV set, noise may appear in images. In this event relocate cables or reinstall equipment.

- **Check the ambient temperature and humidity**

Avoid using the camera where the temperature is hotter or colder than the specified operating range. Doing so could affect the internal parts or cause the image quality to deteriorate. Special care is required to use the camera at high temperature and humidity.

- **Should you notice any trouble**

If any trouble occurs while you are using the camera, turn off the power and contact your dealer. If you continue to use the camera when there is something wrong with it, the trouble may get worse and an unpredictable problem may occur.



Precautions for Use

Disclaimer

We disclaim any responsibility and shall be held harmless for any damages or losses incurred by the user in any of the following cases:

1. Fire, earthquake or any other act of God; acts by third parties; misuse by the user, whether intentional or accidental; use under extreme operating conditions.
2. Malfunction or non-function resulting in indirect, additional or consequential damages, including but not limited to loss of expected income and suspension of business activities.
3. Incorrect use not in compliance with instructions in this user's manual.
4. Malfunctions resulting from misconnection to other equipment.
5. Repairs or modifications made by the user or caused to be made by the user and carried out by an unauthorized third party.
6. Notwithstanding the foregoing, Toshiba's liabilities shall not, in any circumstances, exceed the purchase price of the product.

Copyright and Right of Portrait

There may be a conflict with the Copyright Law and other laws when a customer uses, displays, distributes, or exhibits an image picked up by the camera without permission from the copyright holder. Please also note that transfer of an image or file covered by copyright is restricted to use within the scope permitted by the Copyright Law.

Protection of Personal Information

Images taken by the camera that reveal the likeness of an individual person may be considered personal information. To disclose, exhibit or transmit those images over the internet or otherwise, consent of the person may be required.

Usage Limitation

The product is not designed for any "critical applications." "Critical applications" means life support systems, exhaust or smoke extraction applications, medical applications, commercial aviation, mass transit applications, military applications, homeland security applications, nuclear facilities or systems or any other applications where product failure could lead to injury to persons or loss of life or catastrophic property damage.

Accordingly, [Toshiba/TAIS] disclaims any and all liability arising out of the use of the product in any critical applications.

AC Adapter

Be sure to use only the supplied AC adapter. Using a different AC adapter may cause the camera to malfunction, heat up, or catch fire. Before using the AC adapter, carefully read and observe the Important Safeguards (→ page 6) and the notes below.

- Plug the AC adapter into the 100-240V AC outlet. If inserting it into other than 100-240V AC outlet, it may result in electric shock or fire hazard.
- Do not repair, modify or disassemble the AC adapter. It may result in electric shock or fire hazard.
- Keep the blades of Plug free from any dust or dirt. Neglecting to do so may cause a fire due to deterioration of the insulation. Pull out the power plug from the outlet before cleaning the blades.
- Do not cover or wrap the AC adapter with a cloth or place it near heating devices. It may cause fire or malfunction of the unit.
 - Protect the power cord from being:
 - damaged, modified for extension, or applied heat.
 - pulled, put heavy objects, or pinched.
 - bent, twisted extremely, or bundle.Neglecting to do so may cause electric shock or fire hazard.
- Do not expose this AC adapter to water.
- Install the AC adapter properly on a wall or ceiling after plugging in the AC adapter. Avoid dropping the AC adapter, failing to do so may cause serious personal injury or death.
- Do not allow the connectors on the AC adapter to come into contact with any other metal object as this may result in short circuit.
- To connect the AC adapter, firmly insert the plug end of the cable into the AC adapter jack. Do not insert the plug into other jacks as this may cause a malfunction.
- When removing the connection cable, disconnect the cable by holding its plug. Do not disconnect the cable by pulling on the cable.
- Do not drop the AC adapter or subject it to strong impact.
- Do not use the AC adapter in hot and humid places.
- Do not use the supplied AC adapter with devices other than this camera.
- Temperature increasing on the surface of the adapter is normal. Before moving the adapter to another location, unplug it from the wall outlet, and wait until its temperature decreases.
- Buzzing noises may come from inside. This does not indicate malfunction.
- Using the AC adapter near a radio, TV, cellphone, or any wireless devices/equipment may cause interference. Use the adapter at sufficient distances from these devices.
- Be sure to use the supplied AC adapter. Using different AC adapter may cause fire hazard or the camera to malfunction.

Specifications

AC adapter (AH1812-B)

Power source	: 100-240V AC 50/60 Hz 18 W
Rated output	: 12V DC, 1.5 A
Ambient temperature guaranteed for performance	: 0° C to 40° C (32° F to 104° F)
Storage temperature	: -25° C to 85° C (-13° F to 185° F)
Maximum external dimensions	: 34.5 x 75 x 46.5 mm (1.358 x 2.953 x 1.831 inches) (width x height x depth)
Cord length	: 1800 mm (70.866 inches)

Package Contents

- IK-WD12A

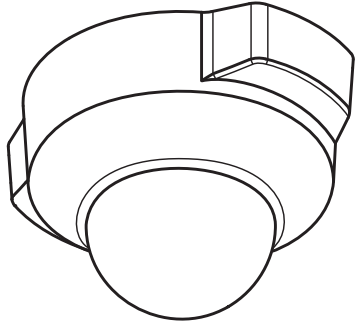

- AC Adapter

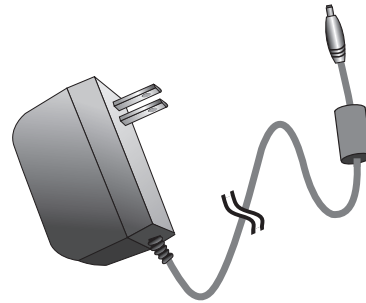

- CD-ROM

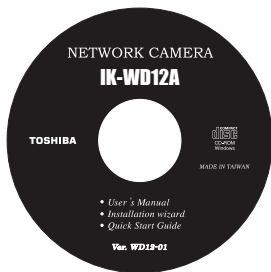

- Alignment Sticker

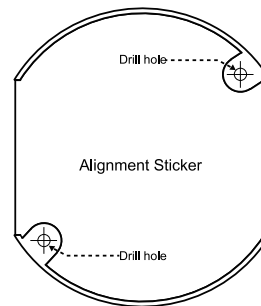

- Warranty Card



- Quick Start Guide and Important Safeguards



- Torx driver

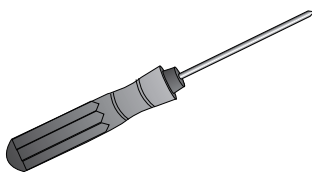

- Screws and I/O Connector

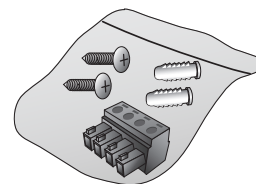

Physical Description

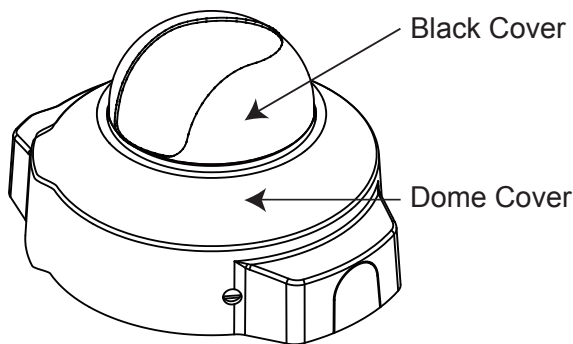
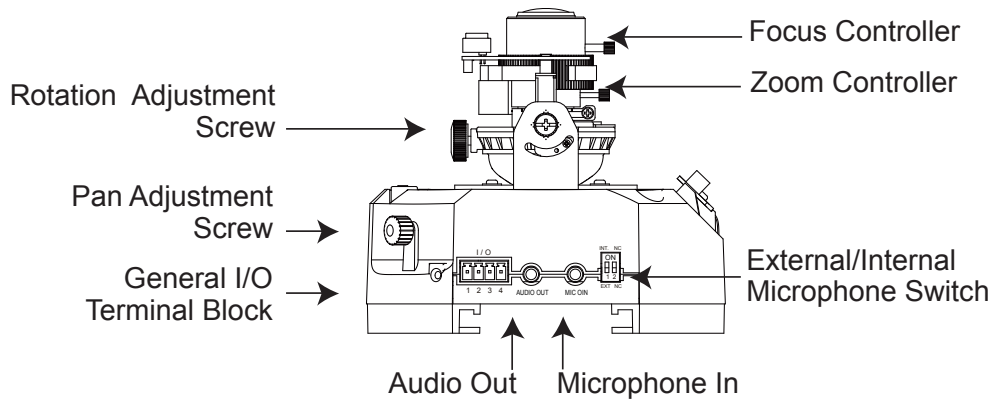
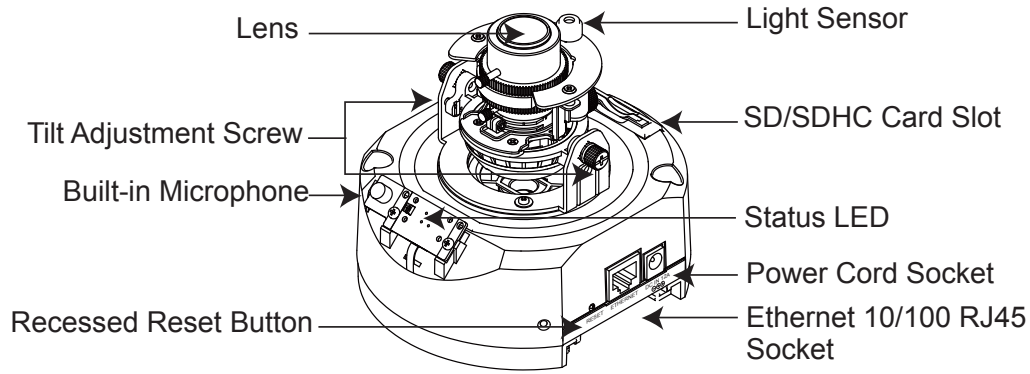

Treat the dome cover with care when installing, Or it may be damaged.

Record the MAC address under the camera base before installing the camera.

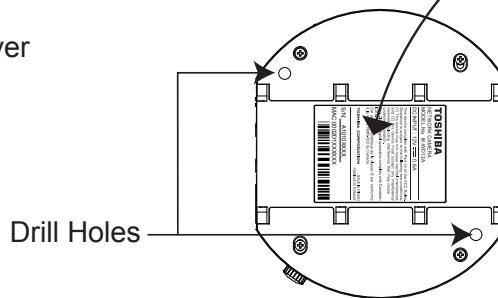

General I/O Terminal Block

This Network Camera provides a general I/O terminal block which is used to connect external input / output devices. The pin definitions are described below.

Pin	Name
1	12V DC Output
2	Digital Output
3	Digital Input
4	Ground

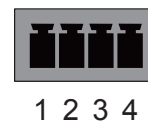

NOTE

- 12V DC is outputted from 1-pin only when connected to a power supply.

The diagrams below apply when "Digital Input" is used for an alarm input.

	Internal Circuit	Signal Condition
<p>Digital Input</p>		<p>Active state is low.</p> <p>Active state is high.</p>
<p>Digital Output</p>		<p>MAX. 12 VDC, 400 mA</p>

Status LED

The LED indicates the status of the Network Camera.

Item	LED status	Description
1	All LED lit=> All LED unlit=> Steady Red => Steady Red + Blink Green once per sec.	System booting
2	Steady Red	Power on; Network fail
3	Blink Green every 1 sec.	Network works
4	Blink Orange/ Yellow every 0.15sec	Upgrading F/W
5	Blink Red every 0.15sec	Restore default
6	Press the reset button until all LEDs blink fast (0.15sec/time), then release the reset button	Reset button for reset

Hardware Reset

The reset button is used to reset the system or restore the factory default settings. Occasionally resetting the system can return the camera to normal operation. If the system problems remain after resetting restore the factory settings and install again.

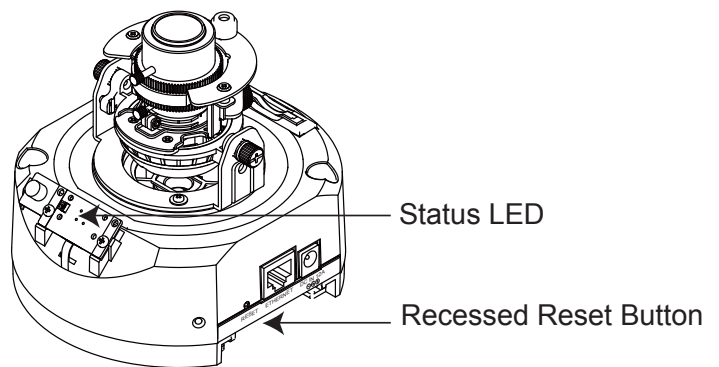

Reset: Hold for about 2 seconds and release the recessed reset button with a paper clip or small object. Wait for the Network Camera to reboot.

Restore: Press and hold the recessed reset button until the status LED rapidly blinks. It takes about 30 seconds. Note that all settings will be restored to factory default. Upon successful restore, the status LED will blink during normal operation.



Restoring the factory defaults will erase any previous settings.

SD/SDHC Card and Capacity

This network camera is compliant with SD/SDHC 16GB / 8GB and other preceding standard SD cards for local storage.

NOTE

- There is a limit to the number of rewrites that is possible with the SD memory card. Replacing the SD memory card when performing periodic maintenance of the camera is recommended.
- Do not use 512MB and below SD memory cards.
- The Camera system reserves approximately 60MB in SD memory cards. Any images are not recordable on this space.
- Carefully read the User's guide, precautions on use, and any other information supplied with a purchased memory card.
- An SD memory card can be used for repeated storage. The lifespan (number of rewrites possible) of an SD memory card is greatly affected by the capacity of the SD memory card.
- Do not use a memory card containing the data recorded by another device with the camera as this may result in the camera not functioning correctly.
- Do not modify, overwrite the data, or change the folder name of an SD memory card. It may result in the camera not to function correctly.
- If you unmount or remove the SD memory card from camera, you have to turn OFF the recording status in Recording window on page 98 and Application window on page 85.

Installation

Hardware Installation

Please verify that your product package contains all the accessories listed in the Package Contents listed on page 10. Depending on the user's application, an Ethernet cable may be needed. The Ethernet cable should meet the specs of UTP Category 5.

Hardware Installation is shown in the Quick Start Guide(QSG). Please refer to page 12 of the QSG.

Network Deployment

In this user's manual, "User" refers to whoever has access to the Network Camera, and "Administrator" refers to the person who can configure the Network Camera and grant user access to the camera.

Network Deployment is shown in the Quick Start Guide(QSG). Please refer to page 13 of the QSG.

Setting up the Network Camera over the Internet

There are several ways to set up the Network Camera over the Internet. The first way is to set up the Network Camera behind a router. The second way is to utilize a static IP. The third way is to use PPPoE.

Internet connection via a router

Before setting up the Network Camera over the Internet, make sure you have a router and follow the steps below.

1. Connect your Network Camera behind a router, the Internet environment is illustrated below. Regarding how to obtain your IP address, please refer to Software Installation on page 20 for details.

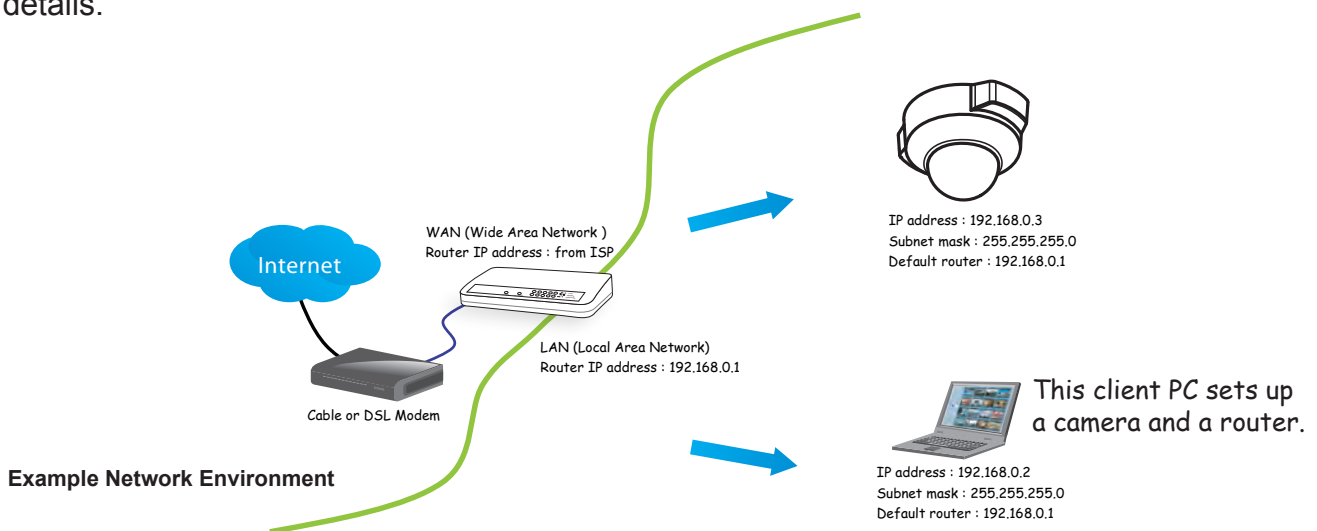

2. In this case, if the Local Area Network (LAN) IP address of your Network Camera is 192.168.0.3, please forward the following ports for the Network Camera on the router.

- HTTP port
- RTSP port
- RTP port for audio
- RTCP port for audio
- RTP port for video
- RTCP port for video

If you have changed the port numbers on the Network page, please open the ports accordingly on your router. For information on how to forward ports on the router, please refer to your router's user's manual.

3. Determine the public IP address of your router provided by your ISP (Internet Service Provider). Use the public IP and the secondary HTTP port to access the Network Camera from the Internet. Please refer to Network Type on page 42 for details.

Internet connection with static IP

Choose this connection type if you are required to use a static IP for the Network Camera. Please refer to LAN on page 42 for details.

Internet connection via PPPoE (Point-to-Point over Ethernet)

Choose this connection type if you are connected to the Internet via a DSL Line. Please refer to PPPoE on page 43 for details.

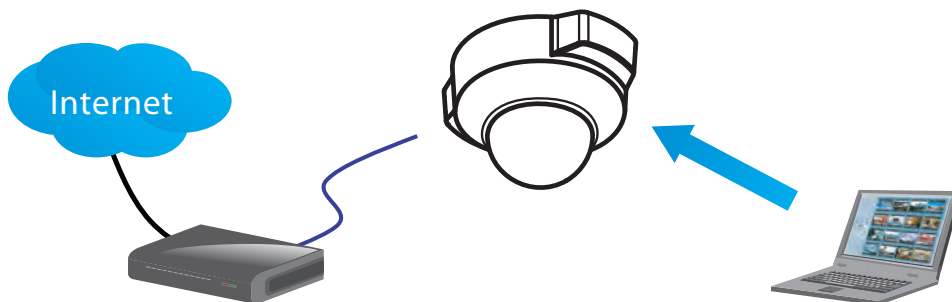

Software Installation

Installation Wizard (IW), a free-bundled software packaged in the product CD, helps to set up your Network Camera in a LAN.



1. Install the IW under the Software Utility directory from the software CD. Double click the IW shortcut on your desktop to launch the program.
2. The program will analyze your network environment. After your network environment is analyzed, please click Next to continue the program.

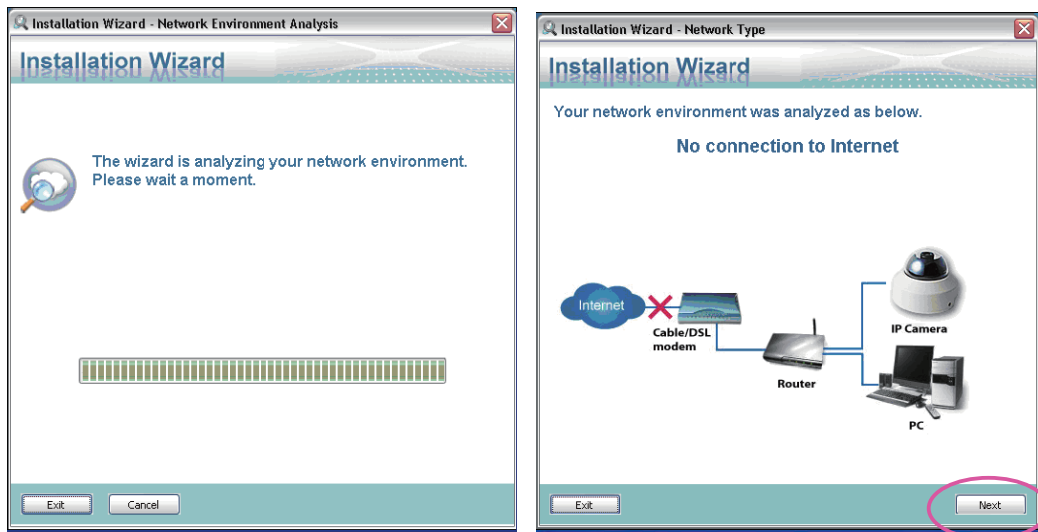

3. The program will search for Network Cameras on the same LAN.
4. After searching, the main installer window will pop up. Click on the MAC and model name which matches the MAC of the camera.

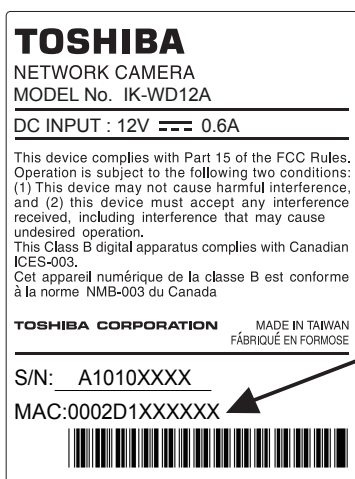

NOTE

- This Software is proprietary client software for TOSHIBA Network Camera.

Ready to Use

1. Access the Network Camera on the LAN.
2. Retrieve live video through a web browser.

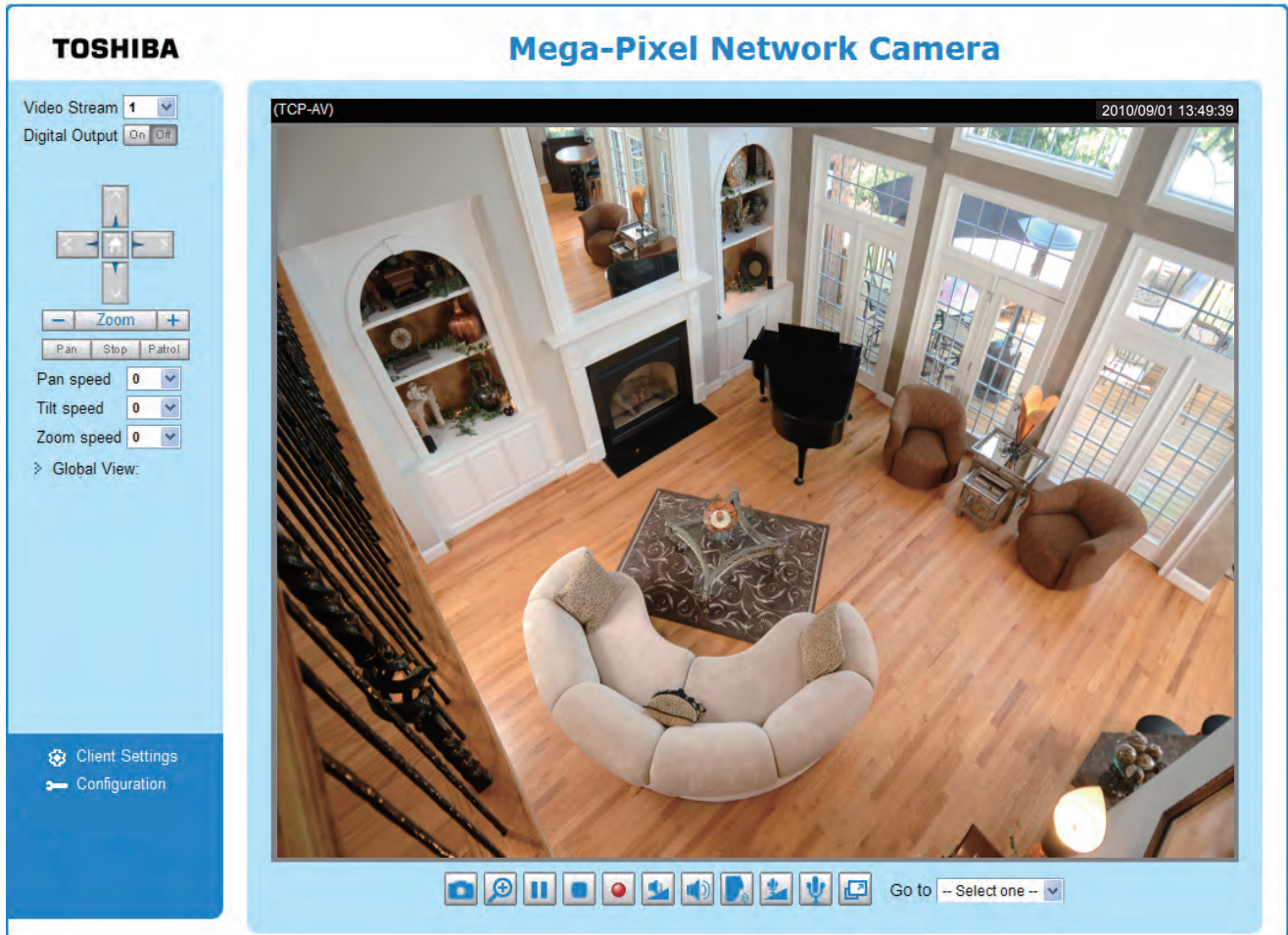

Adjusting the Lens

Adjusting the Lens is shown in the Quick Start Guide (QSG). Please refer to 17 pages of QSG.

Completion

Completion is shown in the Quick Start Guide (QSG). Please refer to 19 pages of QSG.

Accessing the Network Camera

This chapter explains how to access the Network Camera through web browsers, RTSP players and 3GPP-compatible mobile devices.

Using Web Browsers

Use Installation Wizard to access the Network Cameras on the LAN.

If your network environment is not a LAN, follow these steps to access the Network Camera:

1. Launch your web browser (Microsoft® Internet Explorer).
2. Enter the IP address of the Network Camera in the address field. Press **Enter**.
3. The live video will be displayed in your web browser.
4. If it is the first time installing the network camera, an information bar will pop up as shown below. Follow the instructions to install the required plug-in on your computer.

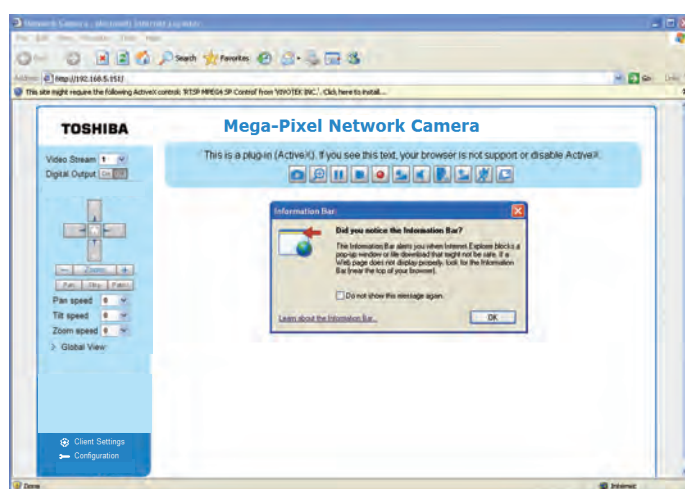

- *By default, the Network Camera is not password-protected. To prevent unauthorized access, it is highly recommended to set a password for the Network Camera. For more information about how to enable password protection, please refer to Security on page 35.*

► If you see a dialog box indicating that your security settings prohibit running ActiveX® Controls, please enable the ActiveX® Controls for your browser.

1. Choose *Tools > Internet Options > Security > Custom Level*.

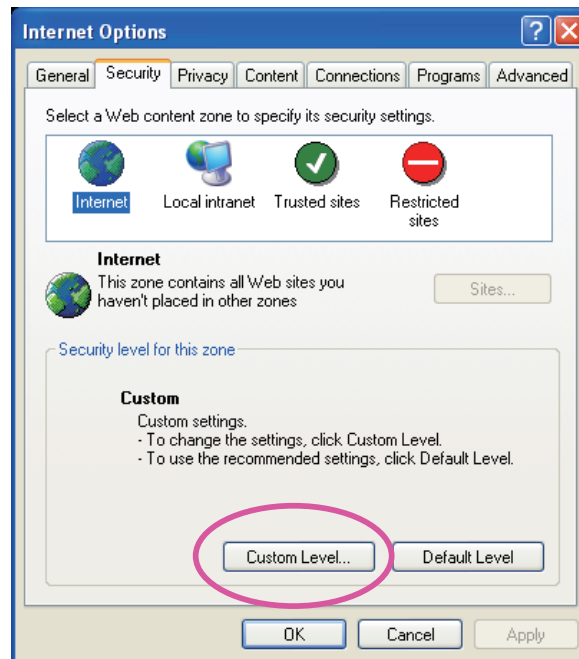

2. Look for *Download signed ActiveX® controls*; select *Enable or Prompt*. Click **OK**.

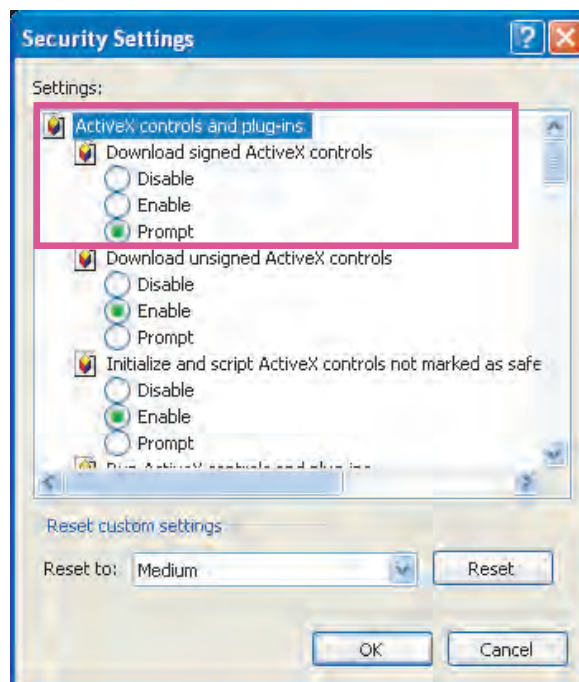

3. Refresh your web browser, then install the Active X® control. Follow the instructions to complete installation.

Using RTSP Players

To view the MPEG-4 streaming media using RTSP players, you can use players that support RTSP streaming.

1. Launch the RTSP player.
2. Choose File > Open URL. A URL dialog box will pop up.
3. The address format is `rtsp://<ip address>:<rtsp port>/<RTSP streaming access name for stream1 or stream2>`

As most ISPs and players only allow RTSP streaming through port number 554, please set the RTSP port to 554. For more information, please refer to RTSP Streaming on page 55.

For example:

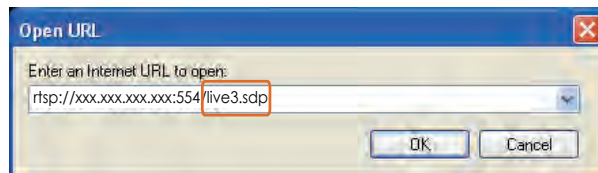

4. The live video will be displayed in your player.
For more information on how to configure the RTSP access name, please refer to RTSP Streaming on page 55 for details.



Using 3GPP-compatible Mobile Devices

To view the streaming media through 3GPP-compatible mobile devices, make sure the Network Camera can be accessed over the Internet. For more information on how to set up the Network Camera over the Internet, please refer to Setup the Network Camera over the Internet on page 18.

To utilize this feature, please check the following settings on your Network Camera:

1. Because most players on 3GPP mobile phones do not support RTSP authentication, make sure the authentication mode of RTSP streaming is set to disable.
For more information, please refer to RTSP Streaming on page 55.
2. As the bandwidth on 3G networks is limited, you will not be able to use a large video size. Please set the video and audio streaming parameters as listed below.
For more information, please refer to Viewing Window on page 67.

Video Mode	MPEG-4
Frame size	176 x 144
Maximum frame rate	5 fps
Intra frame period	1S
Video quality (Constant bit rate)	40kbps
Audio type (GSM-AMR)	12.2kbps

3. As most ISPs and players only allow RTSP streaming through port number 554, please set the RTSP port to 554. For more information, please refer to RTSP Streaming on page 55.
4. Launch the player on the 3GPP-compatible mobile devices.
5. Type the following URL commands into the player.
The address format is `rtsp://<public ip address of your camera>:<rtsp port>/<RTSP streaming access name for stream 3>`.
For example:

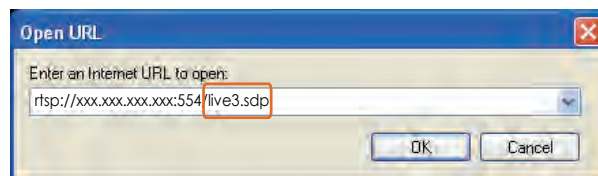

Main Page

This chapter explains the layout of the main page. It is composed of the following sections: TOSHIBA Logo, Host Name, Camera Control Area, Configuration Area, Menu, and Live Video Window.

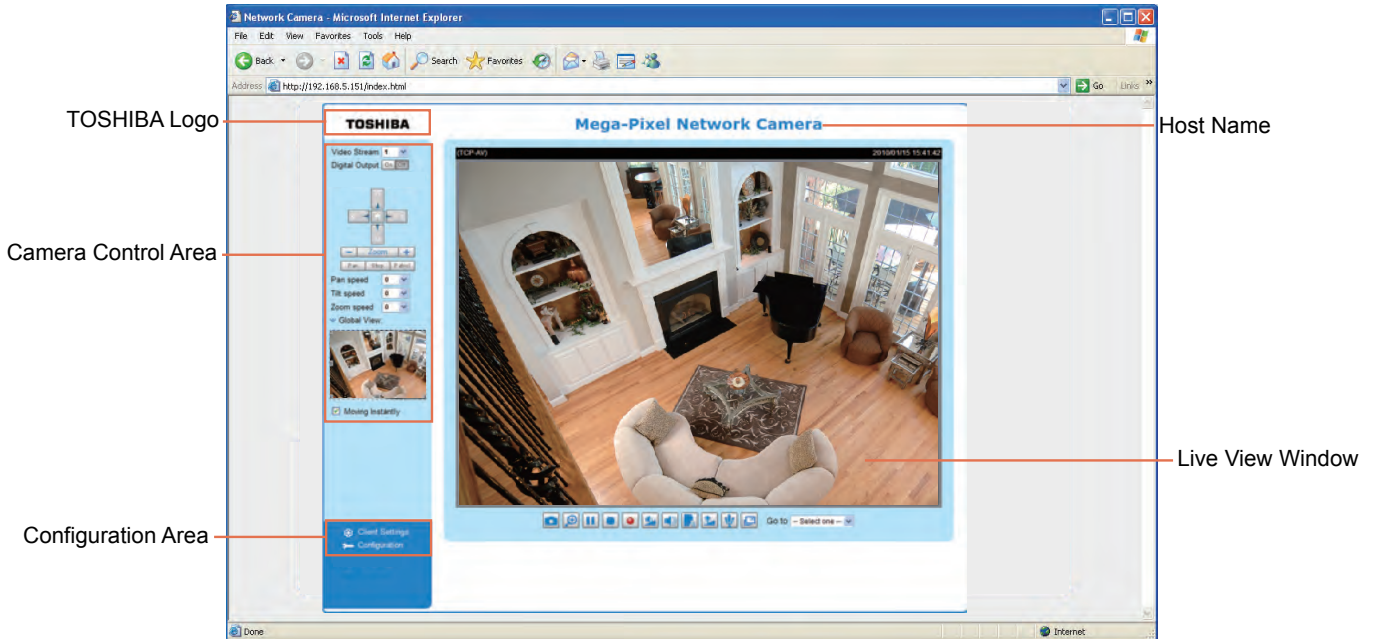

TOSHIBA Logo

Click this logo to visit the TOSHIBA website.

Host Name

The host name can be customized to fit your needs. For more information, please refer to System on page 33.

Camera Control Area

Video Stream: This Network Camera supports multiple streams (stream 1 ~ 4) simultaneously. You can select either one for live viewing. For more information about multiple streams, please refer to page 67 for detailed information.

Digital Output: Click to turn the digital output device on or off.

PTZ Panel: This Network Camera supports both “digital” (e-PTZ) and “mechanical” pan/tilt/zoom control. Please refer to Camera Control on page 78 for detailed information.

Global View: Click on this item to display the Global View window. The Global View window contains a full view image (the largest frame size of the captured video) and a floating frame (the viewing region of the current video stream). The floating frame allows users to control the e-PTZ function (Electronic Pan/Tilt/Zoom). For more information about e-PTZ operation, please refer to E-PTZ Operation on page 81. For more information about how to set up the viewing region of the current video stream, please refer to Viewing Windows on page 67.

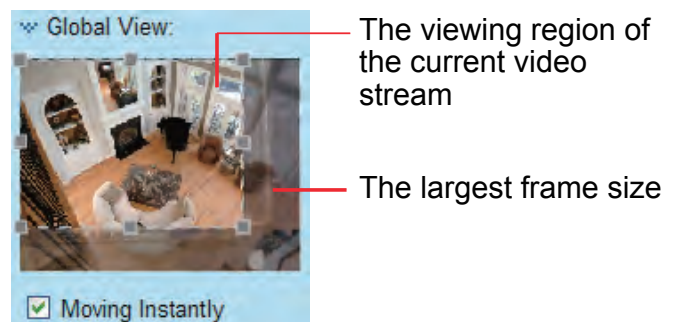

Configuration Area

Client Settings: Click this button to access the client setting page. For more information, please refer to Client Settings on page 30.

Configuration: Click this button to access the configuration page of the Network Camera. It is suggested that a password be applied to the Network Camera so that only the administrator can configure the Network Camera. For more information, please refer to Configuration on page 32.

Live Video Window

- The following window is displayed when the video mode is set to MPEG-4:

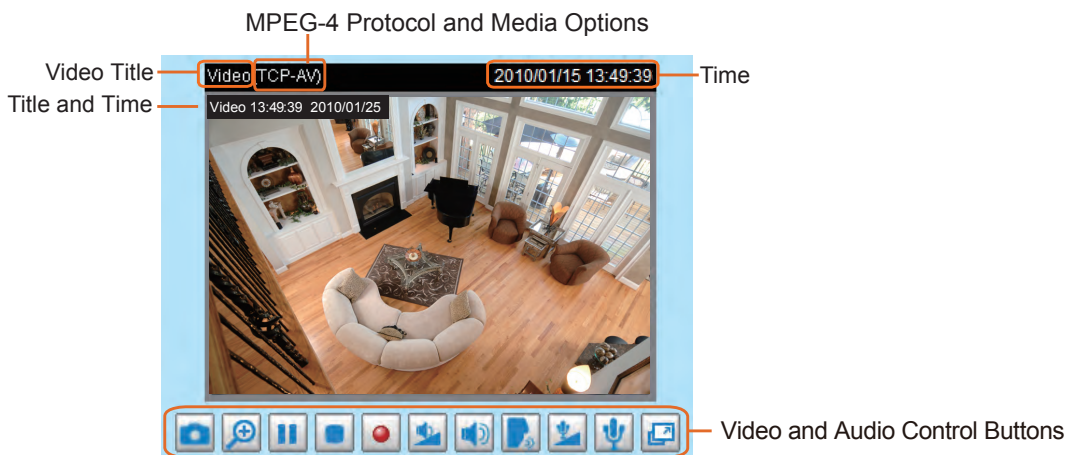

Video Title: The video title can be configured. For more information, please refer to Video Settings on page 61.

MPEG-4 Protocol and Media Options: The transmission protocol and media options for MPEG-4 video streaming. For further configuration, please refer to Client Settings on page 30.

Time: Displays the current time. For further configuration, please refer to Video Settings on page 61.



Title and Time: The video title and time can be stamped on the streaming video. For further configuration, please refer to Video Settings on page 61.



Video and Audio Control Buttons: Depending on the Network Camera model and Network Camera configuration, some buttons may not be available.



 **Snapshot:** Click this button to capture and save still images. The captured images will be displayed in a pop-up window. Right-click the image and choose **Save Picture As** to save it in JPEG (*.jpg) or BMP (*.bmp) format.



 **Digital Zoom:** Click and uncheck “Disable digital zoom” to enable the zoom operation. The navigation screen indicates the part of the image being magnified. To control the zoom level, drag the slider bar. To move to a different area you want to magnify, drag the navigation screen.







 **Pause:** Pause the transmission of the streaming media. The button becomes the  **Resume** button after clicking the Pause button.



 **Stop:** Stop the transmission of the streaming media. Click the  **Resume** button to continue transmission.



 **Start MP4 Recording:** Click this button to record video clips in MP4 file format to your computer. Press the  **Stop MP4 Recording** button to end recording. When you exit the web browser, video recording stops accordingly. To specify the storage destination and file name, please refer to MP4 Saving Options on page 31 for details.

 **Volume:** When the  **Mute** function is not activated, move the slider bar to adjust the volume on the local computer.

 **Mute:** Turn off the volume on the local computer. The button becomes the  **Audio On** button after clicking the Mute button.

 **Talk:** Click this button to talk to people around the Network Camera. Audio will project from the external speaker connected to the Network Camera. Click this button  again to end talking transmission.

 **Mic Volume:** When the  **Mute** function is not activated, move the slider bar to adjust the microphone volume on the local computer.

 **Mute:** Turn off the  **Mic** volume on the local computer. The button becomes the  **Mic On** button after clicking the Mute button.

 **Full Screen:** Click this button to switch to full screen mode. Press the “Esc” key to switch back to normal mode.

■ The following window is displayed when the video mode is set to MJPEG:

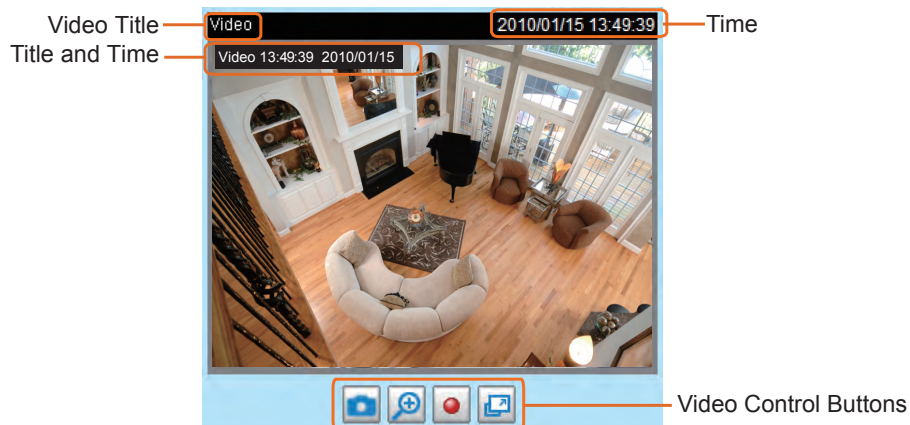



Video Title: The video title can be configured. For more information, please refer to Video Settings on page 61.

Time: Displays the current time. For more information, please refer to Video Settings on page 61.



Title and Time: Video title and time can be stamped on the streaming video. For more information, please refer to Video Settings on page 61.

Video and Audio Control Buttons: Depending on the Network Camera model and Network Camera configuration, some buttons may not be available.

 **Snapshot:** Click this button to capture and save still images. The captured images will be displayed in a pop-up window. Right-click the image and choose **Save Picture As** to save it in JPEG (*.jpg) or BMP (*.bmp) format.

 **Digital Zoom:** Click and uncheck “Disable digital zoom” to enable the zoom operation. The navigation screen indicates the part of the image being magnified. To control the zoom level, drag the slider bar. To move to a different area you want to magnify, drag the navigation screen.



 **Start MP4 Recording:** Click this button to record video clips in MP4 file format to your computer. Press the  **Stop MP4 Recording** button to end recording. When you exit the web browser, video recording stops accordingly. To specify the storage destination and file name, please refer to MP4 Saving Options on page 31 for details.

 **Full Screen:** Click this button to switch to full screen mode. Press the “Esc” key to switch back to normal mode.

Client Settings

This chapter explains how to select the stream transmission mode and saving options on the local computer. When completed with the settings on this page, click **Save** on the page bottom to enable the settings.

Clicking the Client Settings in Configuration Area of a Main Page, the following window is shown.

MPEG-4 Media Options

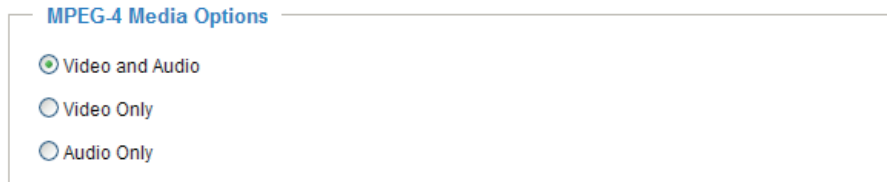

MPEG-4 Media Options

- Video and Audio
- Video Only
- Audio Only

Select to stream video or audio data or both. This is enabled only when the video mode is set to MPEG-4.

MPEG-4 Protocol Options

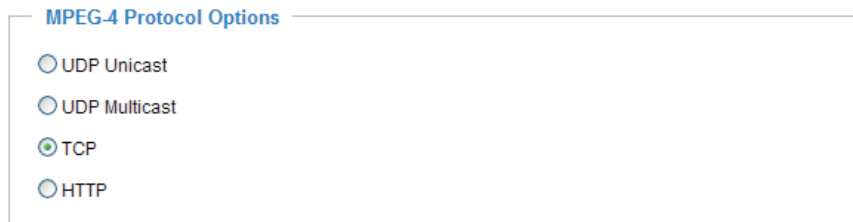

MPEG-4 Protocol Options

- UDP Unicast
- UDP Multicast
- TCP
- HTTP

Depending on your network environment, there are four transmission modes of MPEG-4 streaming:

UDP unicast: This protocol allows for more real-time audio and video streams. However, network packets may be lost due to network burst traffic and images may be broken. Activate UDP connection when occasions require time-sensitive responses and the video quality is less important. Note that each unicast client connecting to the server takes up additional bandwidth and the Network Camera allows up to ten simultaneous accesses.

UDP multicast: This protocol allows multicast-enabled routers to forward network packets to all clients requesting streaming media. This helps to reduce the network transmission load of the Network Camera while serving multiple clients at the same time. Note that to utilize this feature, the Network Camera must be configured to enable multicast streaming at the same time. For more information, please refer to RTSP Streaming on page 55.

TCP: This protocol guarantees the complete delivery of streaming data and thus provides better video quality. The downside of this protocol is that its real-time effect is not as good as that of the UDP protocol.

HTTP: This protocol allows the same quality as TCP protocol without needing to open specific ports for streaming under some network environments. Users inside a firewall can utilize this protocol to allow streaming data through.

MP4 Saving Options

MP4 Saving Options

Folder:

File name prefix:

Add date and time suffix to file name

Users can record live video as they are watching it by clicking  Start MP4 Recording on the main page. Here, you can specify the storage destination and file name.

Folder: Specify a storage destination for the recorded video files.

File name prefix: Enter the text that will be appended to the front of the video file name.

Add date and time suffix to the file name: Select this option to append the date and time to the end of the file name.

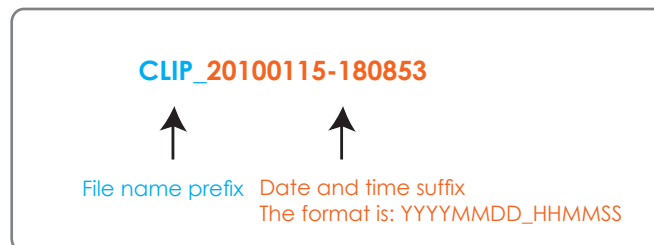

Configuration

Click **Configuration** on the main page to enter the camera setting pages shown below. Note that only Administrators can access the configuration page.

TOSHIBA offers an easy-to-use user interface that helps you set up your network camera with minimal effort. To simplify the setting procedure, two types of user interfaces are available: Advanced Mode for professional users and Basic Mode for entry-level users. Some advanced functions (HTTPS/ Access list/ Homepage layout/ Application/ Recording/ System log/ View parameters) are not displayed in Basic Mode.

If you want to set up advanced functions, please click **[Advanced Mode]** on the bottom of the configuration list to quickly switch to Advanced Mode.

In order to simplify the user interface, the detailed information will be hidden unless you click on the function item. When you click on the first sub-item, the detailed information for the first sub-item will be displayed; when you click on the second sub-item, the detailed information for the second sub-item will be displayed and that of the first sub-item will be hidden.

The following is the interface of the Basic Mode and the Advanced Mode:

Basic Mode

The screenshot displays the Toshiba camera configuration interface in Basic Mode. The interface is divided into a sidebar menu on the left and a main content area on the right. The sidebar menu includes options such as Home, System, Security, Network, DDNS, Audio and video, Motion detection, Camera tampering detection, Camera control, and Maintenance. The main content area is titled ">System" and contains several configuration sections: "System" (Host name: Mega-Pixel Network Camera, Turn off the LED indicator checkbox), "Configuration List" (System Time: Keep current date and time selected, Synchronize with computer time, Manual, Automatic), and "DI and DO" (Digital input: The active state is Low, the current state detected is High; Digital output: The active state is Grounded, the current state detected is Open). A "Save" button is located at the bottom of the main content area. Annotations include: "Click to switch to Advanced Mode" pointing to the "[Advanced mode]" link in the sidebar, and "Firmware Version" pointing to "Version: 0100a" at the bottom left.

Advanced Mode

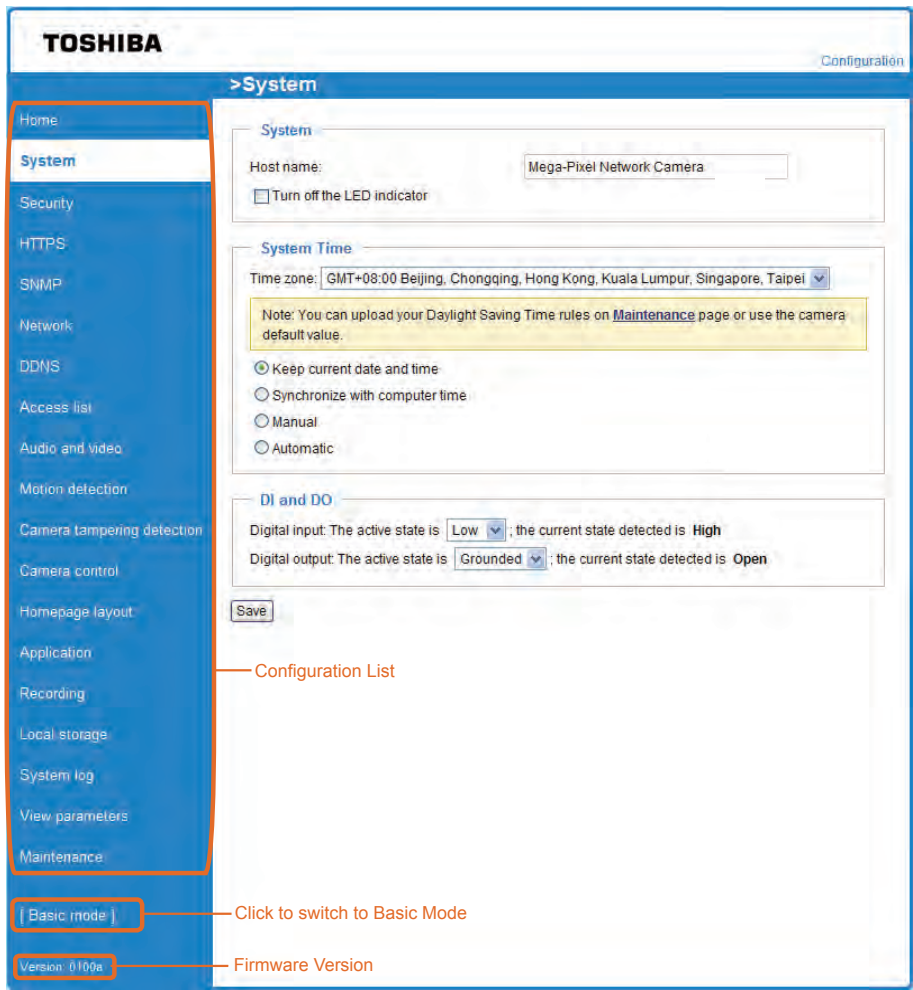

Each function on the configuration list will be explained in the following sections. Those functions that are displayed only in Advanced Mode are marked with **Advanced Mode**. If you want to set up advanced functions, please click **[Advanced Mode]** on the bottom of the configuration list to quickly switch over.

System

This section explains how to configure the basic settings for the Network Camera, such as the host name and system time. It is composed of the following three columns: System, System Time and DI and DO. When finished with the settings on this page, click **Save** at the bottom of the page to enable the settings.

System

System

Host name:

Turn off the LED indicator

Host name: Enter a desired name for the Network Camera. The text will be displayed at the top of the main page.

Turn off the LED indicators: If you do not want to let others know that the network camera is in operation, you can select this option to turn off the LED indicators.

System Time

System Time

Time zone: GMT-07:00 Arizona

Note: You can upload your Daylight Saving Time rules on [Maintenance](#) page or use the camera default value.

Keep current date and time

Sync with computer time:

Manual:

Automatic:

Keep current date and time: Select this option to preserve the current date and time of the Network Camera. The Network Camera's internal real-time clock maintains the date and time even when the power of the system is turned off.

Sync with computer time: Select this option to synchronize the date and time of the Network Camera with the local computer. The read-only date and time of the PC is displayed as updated.

Manual: The administrator can enter the date and time manually. Note that the date and time format are [yyyy/mm/dd] and [hh:mm:ss].

Automatic: The Network Time Protocol is a protocol which synchronizes computer clocks by periodically querying an NTP Server.

NTP server: Assign the IP address or domain name of the time-server. Leaving the text box blank connects the Network Camera to the default time servers.

Update interval: Select to update the time using the NTP server on an hourly, daily, weekly, or monthly basis.

Time zone **Advanced Mode:** Select the appropriate time zone from the list. If you want to upload Daylight Savings Time rules on the Maintenance page, please refer to Upload / Export Daylight Saving Time Configuration File on page 107 for details.

DI and DO

DI and DO

Digital input: The active state is Low ; the current state detected is High

Digital output: The active state is Grounded ; the current state detected is Open

Save

Digital input: Select High or Low to define normal status for the digital input. The Network Camera will report the current status.

Digital output: Select Grounded or Open to define normal status for the digital output. The Network Camera will show whether the trigger is activated or not.

Security

This section explains how to enable password protection and create multiple accounts.

Root Password

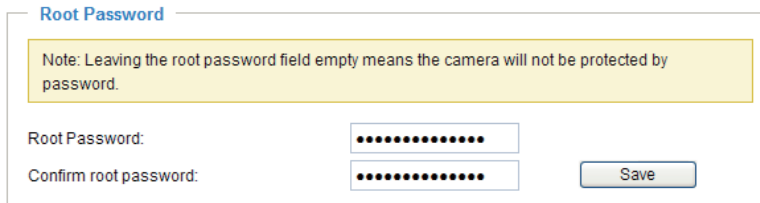

The administrator account name is “root”, which is permanent and can not be deleted. If you want to add more accounts in the Manage User column, please apply the password for the “root” account first.

1. Type the password identically in both text boxes, then click **Save** to enable password protection.
2. A window will be prompted for authentication; type the correct user’s name and password in their respective fields to access the Network Camera.

Manage Privilege **Advanced Mode**



Digital Output & PTZ control: You can modify the manage privilege of operators or viewers. Check or uncheck the item, then click **Save** to enable the settings. If you give Viewers the privilege, Operators will also have the ability to control the Network Camera through the main page. (Please refer to Main Page on page 26.)

Allow anonymous viewing for 3GPP-compatible mobile devices: If you check this item, many 3GPP client can access the live stream without entering a User ID and Password.

NOTE

- Select RTSP Streaming Authentication to disable.
- This function will not work with Internet Explorer.

Manage User

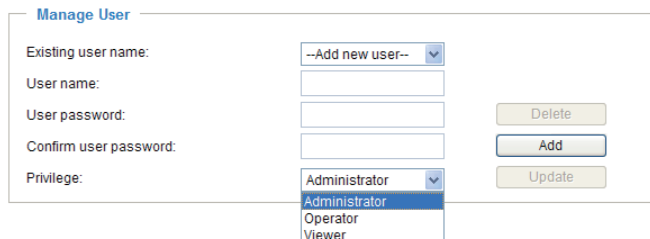

Administrators can add up to 20 user accounts.

1. Input the new user’s name and password.
2. Select the privilege level for the new user account. Click **Add** to enable the setting.

Access rights are sorted by user privilege (Administrator, Operator, and Viewer). Only administrators can access the Configuration page. Though operators cannot access the Configuration page, they can use the URL Commands to get and set the value of parameters. For more information, please refer to URL Command Guide. Viewers access only the main page for live viewing.

Here you also can change a user’s access rights or delete user accounts.

1. Select an existing account to modify.
2. Make necessary changes and click **Update** or **Delete** to enable the setting.

HTTPS (Hypertext Transfer Protocol over SSL) Advanced Mode

This section explains how to enable authentication and encrypted communication over SSL (Secure Socket Layer). It helps protect streaming data transmission over the Internet on higher security level.

Enable HTTPS

Check this item to enable HTTPS communication, then select a connection option: "HTTP & HTTPS" or "HTTPS only". Note that you have to create and install a certificate first in the second column before clicking the **Save** button.

Enable HTTPS

*To enable HTTPS, you have to create and install certificate first.

Enable HTTPS secure connection:

HTTP & HTTPS HTTPS only

Save

Create and install certificate method

Create self-signed certificate automatically

Create self-signed certificate manually:

Create certificate request and install:

Create and Install Certificate Method

Before using HTTPS for communication with the Network Camera, a **Certificate** must be created first. There are three ways to create and install a certificate:

Create self-signed certificate automatically

1. Select this option.
2. In the first column, check **Enable HTTPS secure connection**, then select a connection option: "HTTP & HTTPS" or "HTTPS only".
3. Click **Save** to generate a certificate.

Enable HTTPS

*To enable HTTPS, you have to create and install certificate first.

Enable HTTPS secure connection:

HTTP & HTTPS HTTPS only

Save

Create and install certificate method

Create self-signed certificate automatically

Create self-signed certificate manually:

Create certificate request and install:

Please wait while the certificate is being generated...

Certificate Information

Status: Not installed

Property **Remove**

4. The Certificate Information will automatically be displayed in the third column as shown below. You can click **Property** to view detailed information about the certificate.

Certificate Information

Status:	Active
Country:	US
State or province:	Province
Locality:	City Name
Organization:	Organization Name
Organization Unit:	Unit Name
Common Name:	IP Address

5. Click **Home** to return to the main page. Change the address from "http://" to "https://" in the address bar and press **Enter** on your keyboard. Some Security Alert dialogs will pop up. Click **OK** or **Yes** to enable HTTPS.

https://

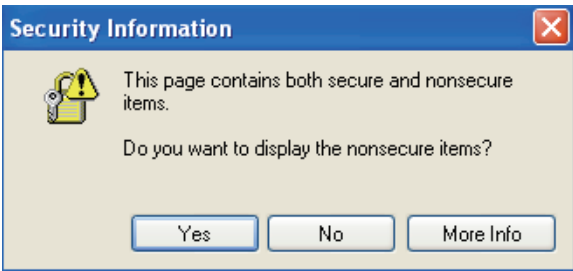
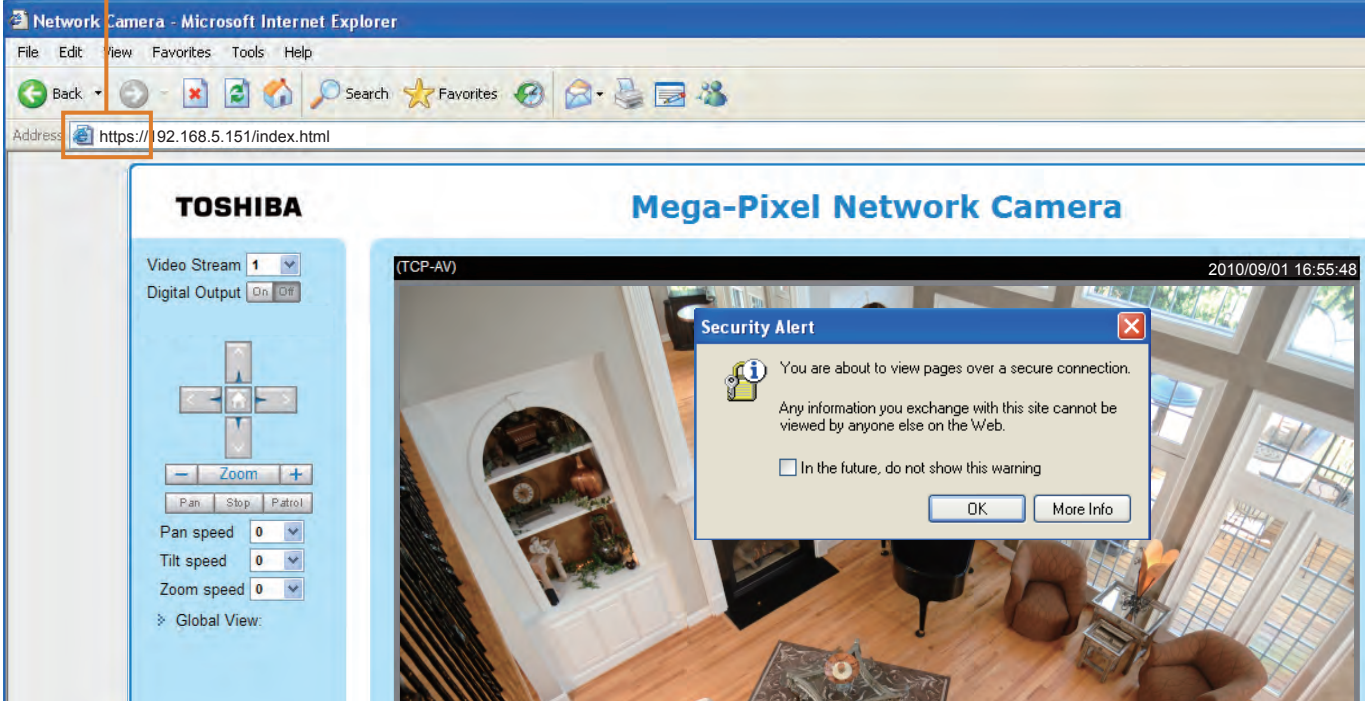

Create self-signed certificate manually

1. Select this option.
2. Click **Create** to open the Create Certificate page, then click **Save** to generate the certificate.

Create and install certificate method

Create self-signed certificate automatically

Create self-signed certificate manually:

Self-signed certificate:

Create certificate request and install:

Create Certificate

Country:

State or province:

Locality:

Organization:

Organization Unit:

Common Name:

Validity: days

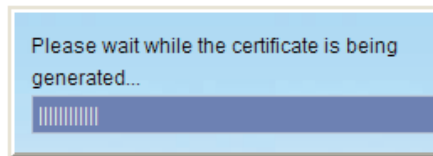

3. The Certificate Information will automatically be displayed in the third column as shown below. You can click **Property** to see detailed information about the certificate.

Certificate Information

Status:

Country: US

State or province: Province

Locality: City Name

Organization: Organization Name

Organization Unit: Unit Name

Common Name: IP Address

Create certificate and install : Select this option if you want to create a certificate from a certificate authority.

1. Select this option.
2. Click **Create** to open the Create Certificate page, then click **Save** to generate the certificate.

Create and install certificate method

Create self-signed certificate automatically

Create self-signed certificate manually:

Create certificate request and install:

Certificate request:

Select certificate file:

Create Certificate

Country:

State or province:

Locality:

Organization:

Organization Unit:

Common Name:

Validity: days

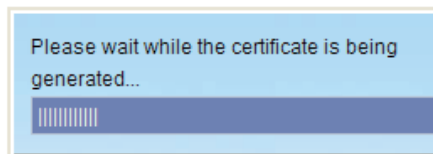

3. If you see the following Information bar, click **OK** and click on the Information bar at the top of the page to allow pop-ups.

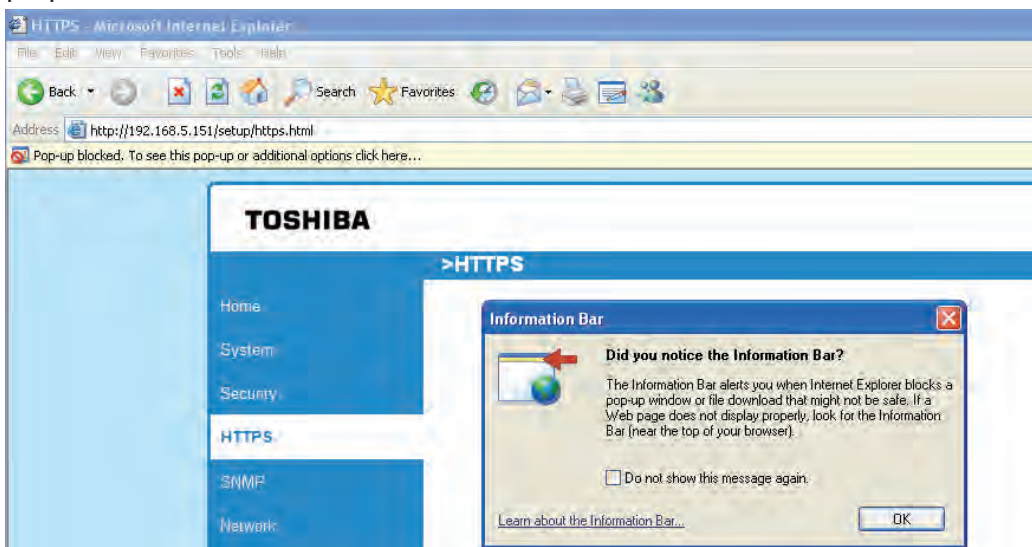

4. The pop-up window shows an example of a certificate request.

Create Certificate Request Completed

Copy the PEM format request below and send it to a CA for identify validation. After that, you have to install it by clicking the "Upload" button on HTTPS page.

Certificate Request (PEM format)

```

-----BEGIN CERTIFICATE REQUEST-----
MIIBuDCcA5ECCADBSMQswCQYDVQQGEwJUVzERMhA8GA1UECBMIUHJvdmluY2UxIjAQBgNVBACTCUNpdHkgTmFtZTEaMBGGA1UEChMRMTNjNjY5pemFOaW9uIE5hbWUxIjAQBgNVBAsTCVvuaXQgTmFtZTEaMBEGA1UEAxMKSVAgQWRkcmVzcCBnzANBgkqhkiG9w0BAQEFAAOBjQAwgYkCgYEAuOT75EY52gsSyPFMx27wHdQ1obPescsXLUx9DFw6OMRheukFaXFDkM+Sxk+K5oEPBPqj77yhH+zdUHS27fSLG57bW9S0xrWuLhSvRZw mCD+//AiJX864dJ/mjHn7Wc55GFaxgMvbALcxT+hCieDCUYnRqh/fpKNj+BxvVoN UrcCAwEAAaAAAMAOGCSqGSIb3DQEBBQUAA4GBAAVazWOatftfU9dyFgTxOYO1D/zO F0TkbndOQG18e4ftJ3rROD1TvIIMjg3K8zsAS8Gd3pME1ejqLYoBrtaSqdCUqGiX 50bLG1subWsXr88PngaBwjYoTpG3q1zvUPJZLAVmdL3ne5urThABXOScCHOQGtH+ PX9dw4OJWkIC8QhV
-----END CERTIFICATE REQUEST-----

```

- Look for a trusted certificate authority that issues digital certificates. Enroll the Network Camera. Wait for the certificate authority to issue a SSL certificate; click **Browse...** to search for the issued certificate, then click Upload in the second column.

Create and install certificate method

Create self-signed certificate automatically
 Create self-signed certificate manually:
 Create certificate request and install:

Certificate request:
 Select certificate file:

Certificate Information

Status: ▾

NOTE

- How do I cancel the HTTPS settings?

- Uncheck **Enable HTTPS secure connection** in the first column and click **Save**; a warning dialog will pop up.
- Click **OK** to disable HTTPS.

Enable HTTPS

*To enable HTTPS, you have to create and install certificate first.

Enable HTTPS secure connection:

Create and install certificate method

Create self-signed certificate automatically
 Create self-signed certificate manually

Microsoft Internet Explorer

?

This will stop the HTTPS service, do you really want to stop it?

- The webpage will redirect to a non-HTTPS page automatically.

- If you want to create and install other certificates, please remove the existing one. To remove the signed certificate, uncheck **Enable HTTPS secure connection** in the first column and click **Save**. Then click **Remove** to erase the certificate.

Certificate Information

Status:

Country:

State or province:

Locality:

Organization:

Organization Unit:

Common Name:

IP Address

Microsoft Internet Explorer

?

Are you sure you want to delete the certificate?

SNMP (Simple Network Management Protocol) Advanced Mode

This section explains how to use the SNMP on the network camera. The Simple Network Management Protocol is an application layer protocol that facilitates the exchange of management information between network devices. It helps network administrators to remotely manage network devices and find, solve network problems with ease.

- The SNMP consists of the following three key components:
 1. Manager: Network-management station (NMS), a server which executes applications that monitor and control managed devices.
 2. Agent: A network-management software module on a managed device which transfers the status of managed devices to the NMS.
 3. Managed device: A network node on a managed network. For example: routers, switches, bridges, hubs, computer hosts, printers, IP telephones, network cameras, web server, and database.

Before configuring SNMP settings on this page, please enable your NMS first.

SNMP Configuration

Enable SNMPv1, SNMPv2c

Select this option and enter the names of Read/Write community and Read Only community according to your NMS settings.

Enable SNMPv1, SNMPv2c

SNMPv1, SNMPv2c Settings

Read/Write community:

Read only community:

Enable SNMPv3

This option contains cryptographic security, a higher security level, which allows you to set the Authentication password and the Encryption password.

- Security name: According to your NMS settings, choose Read/Write or Read Only and enter the community name.
- Authentication type: Select MD5 or SHA as the authentication method.
- Authentication password: Enter the password for authentication (at least 8 characters).
- Encryption password: Enter a password for encryption (at least 8 characters).

Enable SNMPv3

SNMPv3 Settings

Read/Write Security name:

Authentication Type:

Authentication Password:

Encryption Password:

Read only Security name:

Authentication Type:

Authentication Password:

Encryption Password:

Network

This section explains how to configure a wired network connection for the Network Camera.

Network Type

The screenshot shows a 'Network Type' configuration window. The 'LAN' radio button is selected. Under 'LAN', 'Get IP address automatically' is selected, 'Use fixed IP address:' is unselected, 'Enable UPnP presentation' is checked, and 'Enable UPnP port forwarding' is unchecked. Under 'PPPoE', 'Enable IPv6' is unchecked. A 'Save' button is located at the bottom left of the window.

LAN

Select this option when the Network Camera is deployed on a local area network (LAN) and is intended to be accessed by local computers. The default setting for the Network Type is LAN. Remember to click **Save** when you complete the Network setting.

Get IP address automatically: Select this option to obtain an available dynamic IP address assigned by the DHCP server each time the camera is connected to the LAN.

Use fixed IP address: Select this option to manually assign a static IP address to the Network Camera.

The screenshot shows the 'Network Type' configuration window with 'Use fixed IP address:' selected. The 'IP address' field is filled with '192.168.5.109', 'Subnet mask' with '255.255.255.0', 'Default router' with '192.168.5.1', 'Primary DNS' with '192.168.0.10', and 'Secondary DNS' with '192.168.0.20'. 'Primary WINS server' and 'Secondary WINS server' fields are empty. 'Enable UPnP presentation' is checked, and 'Enable UPnP port forwarding' is unchecked. 'PPPoE' and 'Enable IPv6' are unselected. A 'Save' button is at the bottom left.

1. You can make use of TOSHIBA Installation Wizard on the software CD to easily set up the Network Camera on LAN. Please refer to Software Installation on page 20 for details.
2. Enter the Static IP, Subnet mask, Default router, and Primary DNS provided by your ISP.

Enable UPnP presentation: Select this option to enable UPnP™ presentation for your Network Camera so that whenever a Network Camera is presented to the LAN, shortcuts of connected Network Cameras will be listed in My Network Places. You can click the shortcut to link to the web browser. Currently, UPnP™ is supported by Windows XP or later. Note that to utilize this feature, please make sure the UPnP™ component is installed on your computer.

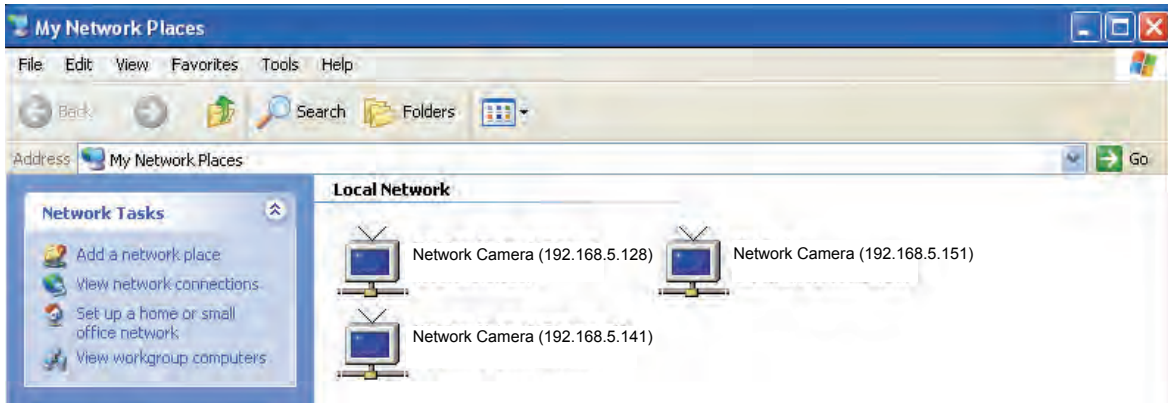

Enable UPnP port forwarding: To access the Network Camera from the Internet, select this option to allow the Network Camera to open ports on the router automatically so that video streams can be sent out from a LAN. To utilize of this feature, make sure that your router supports UPnP™ and it is activated.

PPPoE (Point-to-point over Ethernet)

Select this option to configure your Network Camera to make it accessible from anywhere as long as there is an Internet connection. Note that to utilize this feature, it requires an account provided by your ISP.

Follow the steps below to acquire your Network Camera’s public IP address.

1. Set up the Network Camera on the LAN.
2. Go to Home > Configuration > Application > Server Settings (please refer to Server Settings on page 91) to add a new email or FTP server.
3. Go to Configuration > Application > Media Settings (please refer to Media Settings on page 94). Select System log so that you will receive the system log in TXT file format which contains the Network Camera’s public IP address in your email or on the FTP server.
4. Go to Configuration > Network > Network Type. Select PPPoE and enter the user name and password provided by your ISP. Click **Save** to enable the setting.

Network Type

LAN:

PPPoE:

User name:

Password:

Confirm password:

5. The Network Camera will reboot.
6. Disconnect the power to the Network Camera; remove it from the LAN environment.

NOTE

- If the default ports are already used by other devices connected to the same router, the Network Camera will select other ports for the Network Camera.
- If UPnP™ is not supported by your router, you will see the following message:
Error: Router does not support UPnP port forwarding.

- Steps to enable the UPnP™ user interface on your computer:
 Note that you must log on to the computer as a system administrator to install the UPnP™ components.

1. Go to Start, click **Control Panel**, then click **Add or Remove Programs**.

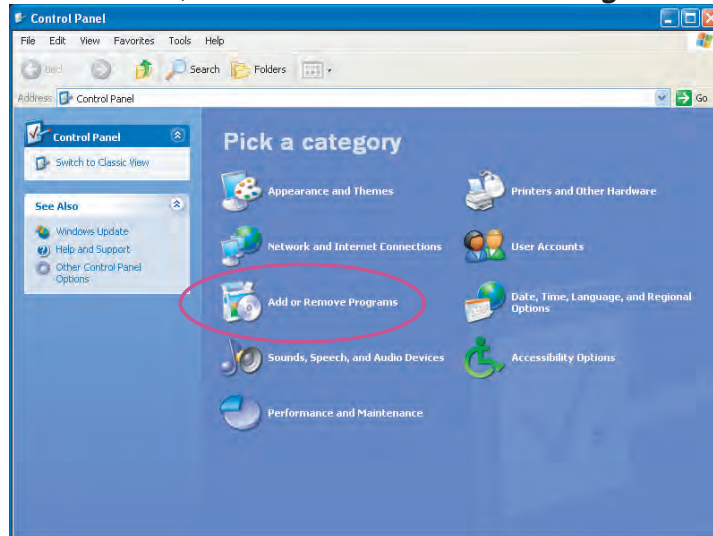

2. In the Add or Remove Programs dialog box, click **Add/Remove Windows Components**.

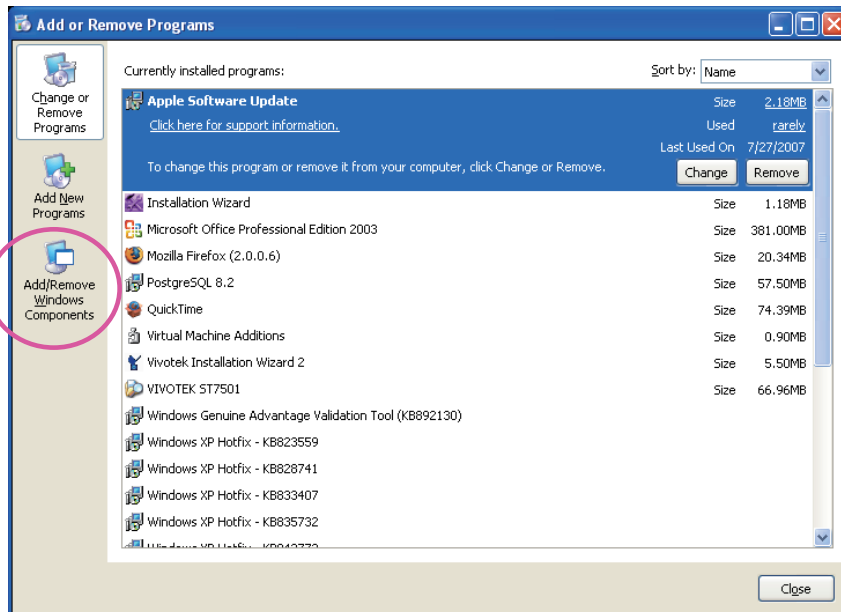

3. In the Windows Components Wizard dialog box, select **Networking Services** and click **Details**.

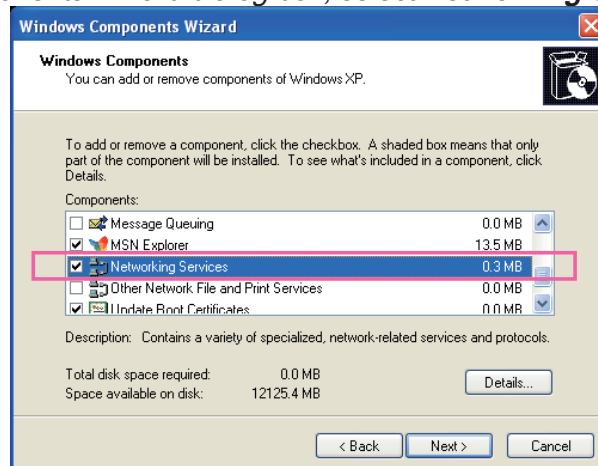

4. In the Networking Services dialog box, select **Universal Plug and Play** and click **OK**.

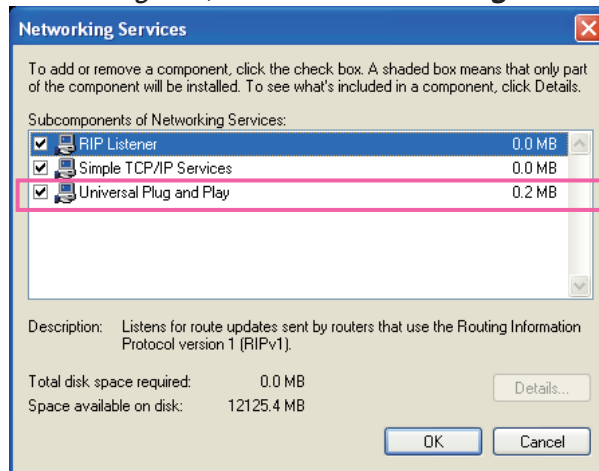

5. Click **Next** in the following window.

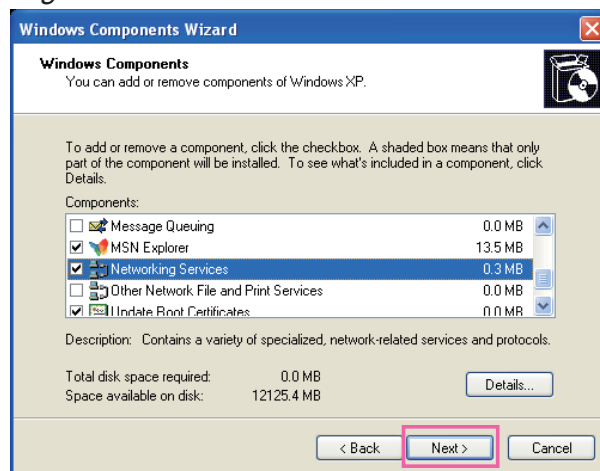

6. Click **Finish**. UPnP™ is enabled.

● **How does UPnP™ work?**

UPnP™ networking technology provides automatic IP configuration and dynamic discovery of devices added to a network. Services and capabilities offered by networked devices, such as printing and file sharing, are available among each other without the need for cumbersome network configuration. In the case of Network Cameras, you will see Network Camera shortcuts under My Network Places.

- Enabling UPnP port forwarding allows the Network Camera to open a secondary HTTP port on the router-not HTTP port-meaning that you have to add the secondary HTTP port number to the Network Camera's public address in order to access the Network Camera from the Internet. For example, when the HTTP port is set to 80 and the secondary HTTP port is set to 8080, refer to the list below for the Network Camera's IP address.

From the Internet	In LAN
http://203.67.124.123:8080	http://192.168.4.160 or http://192.168.4.160:8080

- If the PPPoE settings are incorrectly configured or the Internet access is not working, restore the Network Camera to factory default; please refer to Restore on page 106 for details. After the Network Camera is reset to factory default, it will be accessible on the LAN.

Enable IPv6

Select this option and click **Save** to enable IPv6 settings.

Please note that this only works if your network environment and hardware equipment support IPv6. The browser should be Microsoft® Internet Explorer 6.5 or above.

Network Type

LAN:

- Get IP address automatically
- Use fixed IP address:
- Enable UPnP presentation
- Enable UPnP port forwarding

PPPoE:

- Enable IPv6

Manually setup the IP address

When IPv6 is enabled, by default, the network camera will listen to router advertisements and be assigned with a link-local IPv6 address accordingly.

IPv6 Information: Click this button to obtain the IPv6 information as shown below.

IPv6 NET Information

[eth0 address]
IPv6 address list of host

[Gateway]
IPv6 address list of gateway

[DNS]
IPv6 address list of DNS

If your IPv6 settings are successful, the IPv6 address list will be listed in the pop-up window. The IPv6 address will be displayed as follows:

Refers to Ethernet

[eth0 address]

2001:0c08:2500:0002:0202:d1ff:fe04:65f4/64@Global — Link-global IPv6 address/network mask

fe80:0000:0000:0000:0202:d1ff:fe04:65f4/64@Link — Link-local IPv6 address/network mask

[Gateway]
fe80::211:d8ff:fea2:1a2b

[DNS]
2010:05c0:978d::

Please follow the steps below to link to an IPv6 address:

1. Open your web browser.
2. Enter the link-global or link-local IPv6 address in the address bar of your web browser.
3. The format should be:



4. Press **Enter** on the keyboard or click **Refresh** button to refresh the webpage.
For example:

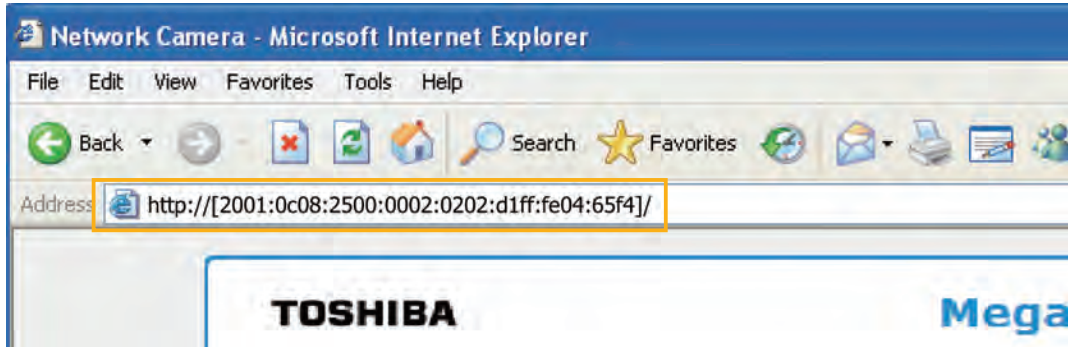

NOTE

- If you have a Secondary HTTP port (the default value is 8080), you can also link to the webpage in the following address format: (Please refer to **HTTP** on page 52 for detailed information.)



- If you choose PPPoE as the Network Type, the [PPP0 address] will be displayed in the IPv6 information column as shown below.

[eth0 address]	fe80:0000:0000:0000:0202:d1ff:fe11:2299/64@Link
[ppp0 address]	fe80:0000:0000:0000:0202:d1ff:fe11:2299/10@Link
	2001:b100:01c0:0002:0202:d1ff:fe11:2299/64@Global
[Gateway]	fe80::90:1a00:4142:8ced
[DNS]	2001:b000:1

Manually setup the IP address: Select this option to manually set up IPv6 settings if your network environment does not have DHCPv6 server and router advertisements-enabled routers.

If you check this item, the following blanks will be displayed for you to enter the corresponding information:

Enable IPv6

IPv6 Information

Manually setup the IP address

Optional IP address / Prefix length / 64

Optional default router

Optional primary DNS

IEEE 802.1x **Advanced Mode**

Enable this function if your network environment uses IEEE 802.1x, which is a port-based network access control. The network devices, intermediary switch/access point/hub, and RADIUS server must support and enable 802.1x settings.

The 802.1x standard is designed to enhance the security of local area networks, which provides authentication to network devices (clients) attached to a network port (wired or wireless). If all certificates between client and server are verified, a point-to-point connection will be enabled; if authentication fails, access on that port will be prohibited. 802.1x utilizes an existing protocol, the Extensible Authentication Protocol (EAP), to facilitate communication.

■ The components of a protected network with 802.1x authentication:

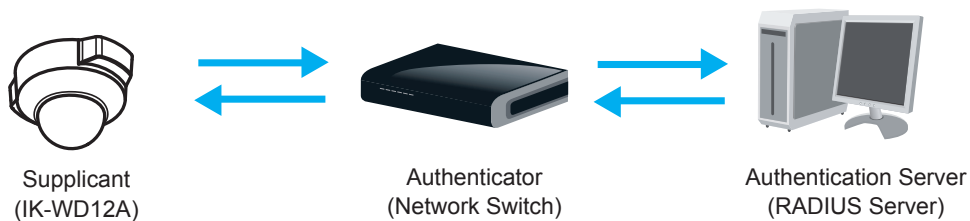

1. Supplicant: A client end user (camera), which requests authentication.
2. Authenticator (an access point or a switch): A “go between” which restricts unauthorized end users from communicating with the authentication server.
3. Authentication server (usually a RADIUS server): Checks the client certificate and decides whether to accept the end user’s access request.

■ The Network Camera support two types of EAP methods to perform authentication: **EAP-PEAP** and **EAP-TLS**.

Please follow the steps below to enable 802.1x settings:

1. Before connecting the Network Camera to the protected network with 802.1x, please apply a digital certificate from a Certificate Authority (ie. MIS of your company) which can be validated by a RADIUS server.
2. Connect the Network Camera to a PC or notebook outside of the protected LAN. Open the configuration page of the Network Camera as shown below. Select **EAP-PEAP** or **EAP-TLS** as the EAP method. In the following blanks, enter your ID and password issued by the CA, then upload related certificate(s).

The screenshot shows the 'IEEE 802.1x' configuration page. The 'Enable 802.1x' checkbox is checked. The 'EAP method' dropdown menu is set to 'EAP-PEAP'. Below this are input fields for 'Identity', 'Password', and 'CA certificate'. The 'CA certificate' field has 'Browse...' and 'Upload' buttons next to it. The 'Status' field shows 'no file' and a 'Remove' button.

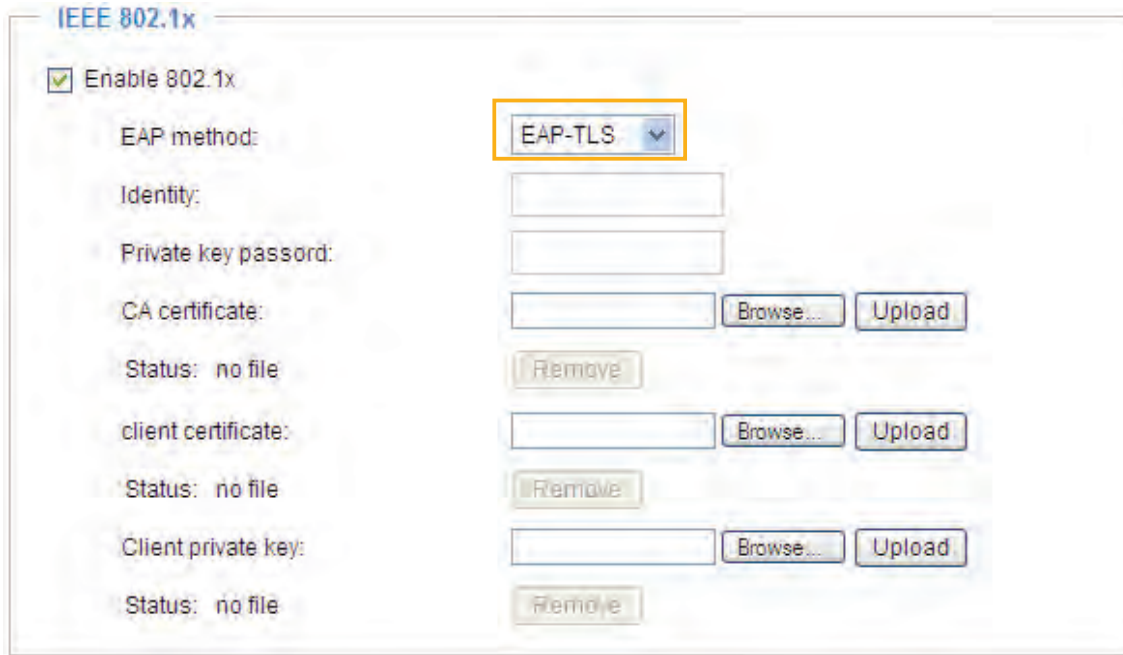

3. When all settings are complete, move the Network Camera to the protected LAN by connecting it to an 802.1x enabled switch. The devices will then start the authentication automatically.

NOTE

- *The authentication process for 802.1x:*

1. *The Certificate Authority (CA) provides the required signed certificates to the Network Camera (the supplicant) and the RADIUS Server (the authentication server).*
2. *A Network Camera requests access to the protected LAN using 802.1X via a switch (the authenticator). The client offers its identity and client certificate, which is then forwarded by the switch to the RADIUS Server, which uses an algorithm to authenticate the Network Camera and returns an acceptance or rejection back to the switch.*
3. *The switch also forwards the RADIUS Server's certificate to the Network Camera.*
4. *Assuming all certificates are validated, the switch then changes the Network Camera's state to authorized and is allowed access to the protected network via a pre-configured port.*

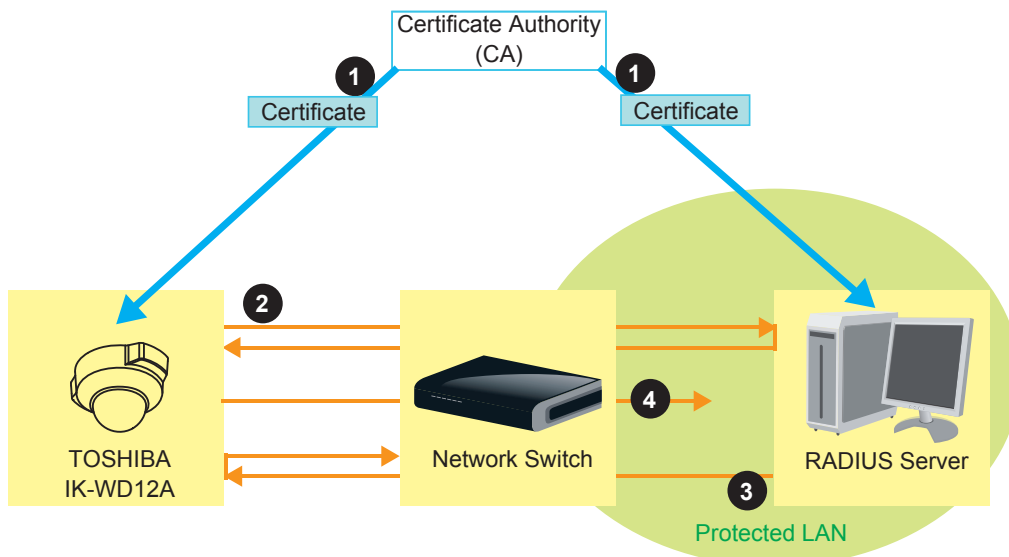

QoS (Quality of Service) Advanced Mode

Quality of Service refers to a resource reservation control mechanism, which guarantees a certain quality to different services on the network. Quality of service guarantees are important if the network capacity is insufficient, especially for real-time streaming multimedia applications. Quality can be defined as, for instance, a maintained level of bit rate, low latency, no packet dropping, etc.

The following are the main benefits of a QoS-aware network:

- The ability to prioritize traffic and guarantee a certain level of performance to the data flow.
- The ability to control the amount of bandwidth each application may use, and thus provide higher reliability and stability on the network.

Requirements for QoS

To utilize QoS in a network environment, the following requirements must be met:

- All network switches and routers in the network must include support for QoS.
- The network video devices used in the network must be QoS-enabled.

QoS models

CoS (the VLAN 802.1p model)

IEEE802.1p defines a QoS model at OSI Layer 2 (Data Link Layer), which is called CoS, Class of Service. It adds a 3-bit value to the VLAN MAC header, which indicates prioritization from 0~7 (Eight different classes of service are available). The priority is set up on the network switches, which then use different queuing disciplines to forward the packets.

Below is the setting column for CoS. Enter the **VLAN ID** of your switch (0~4095) and choose the priority for each application (0~7).

CoS

Enable CoS

VLAN ID:	<input type="text" value="1"/>
Live video:	<input type="button" value="0"/> ▾
Live audio:	<input type="button" value="0"/> ▾
Event/Alarm:	<input type="button" value="0"/> ▾
Management:	<input type="button" value="0"/> ▾

If you assign Video the highest level, the switch will handle video packets first.

NOTE

- The VLAN Switch (802.1p) is required. The web browsing may fail if the CoS setting is incorrect.
- Class of Service technologies do not guarantee a level of service in terms of bandwidth and delivery time; they offer a "best-effort." Users can think of CoS as "coarsely-grained" traffic control and QoS as "finely-grained" traffic control.
- Though CoS is simple to manage, it lacks scalability and does not offer end-to-end guarantees since it is based on L2 protocol.

QoS/DSCP (the DiffServ model)

DSCP-ECN defines QoS at Layer 3 (Network Layer). The Differentiated Services (DiffServ) model is based on packet marking and router queuing disciplines. The marking is done by adding a field to the IP header, called the DSCP (Differentiated Services Codepoint). This is a 6-bit field that provides 64 different class IDs. It gives an indication of how a given packet is to be forwarded, known as the Per Hop Behavior (PHB). The PHB describes a particular service level in terms of bandwidth, queueing theory, and dropping (discarding the packet) decisions. Routers at each network node classify packets according to their DSCP value and give them a particular forwarding treatment; for example, how much bandwidth to reserve for it.

Below are the setting options of DSCP (DiffServ Codepoint). Specify the DSCP value for each application (0~63).

QoS/DSCP

Enable QoS/DSCP

Live video:	<input type="text" value="0"/>
Live audio:	<input type="text" value="0"/>
Event/Alarm:	<input type="text" value="0"/>
Management:	<input type="text" value="0"/>

HTTP Advanced Mode

To utilize HTTP authentication, make sure that you have set a password for the Network Camera first; please refer to Security on page 35 for details.

HTTP	
Authentication:	<input type="text" value="basic"/>
HTTP port:	<input type="text" value="80"/>
Secondary HTTP port:	<input type="text" value="8080"/>
Access name for stream 1:	<input type="text" value="video.mjpg"/>
Access name for stream 2:	<input type="text" value="video2.mjpg"/>
Access name for stream 3:	<input type="text" value="video3.mjpg"/>
Access name for stream 4:	<input type="text" value="video4.mjpg"/>
Access name for stream 5:	<input type="text" value="videoany.mjpg"/>

Authentication: Depending on your network security requirements, the Network Camera provides two types of security settings for an HTTP transaction: basic and digest.

If **basic** authentication is selected, the password is sent in plain text format and there can be potential risks of being intercepted. If **digest** authentication is selected, user credentials are encrypted using MD5 algorithm and thus provide better protection against unauthorized accesses.

HTTP port / Secondary HTTP port: By default, the HTTP port is set to 80 and the secondary HTTP port is set to 8080. They can also be assigned to another port number between 1025 and 65535. If the ports are incorrectly assigned, the following warning messages will be displayed:

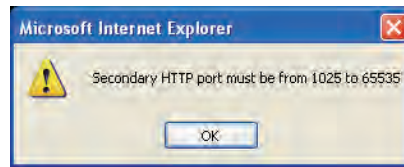

To access the Network Camera on the LAN, both the HTTP port and secondary HTTP port can be used to access the Network Camera. For example, when the HTTP port is set to 80 and the secondary HTTP port is set to 8080, refer to the list below for the Network Camera's IP address.

In LAN
http://192.168.4.160 or
http://192.168.4.160:8080

Access name for stream 1 ~ 5: This Network camera supports multiple streams simultaneously. The access name is used to differentiate the streaming source. Users can click **Configuration > Audio and Video > Video Settings** to set up the video quality of linked streams. For more information about how to set up the video quality, please refer to Viewing Windows on page 67.

HTTPS

HTTPS

HTTPS port:

By default, the HTTPS port is set to 443. It can also be assigned to another port number between 1025 and 65535.

Two way audio

Two way audio

Two way audio port:

By default, the two way audio port is set to 5060. Also, it can also be assigned to another port number between 1025 and 65535.



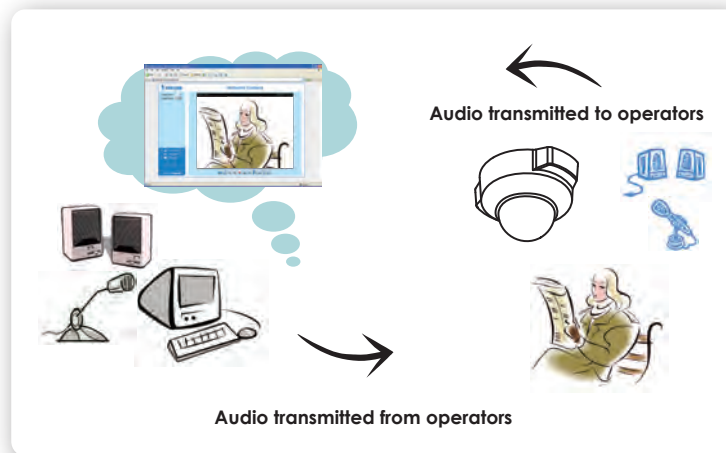

The Network Camera supports two way audio communication so that operators can transmit and receive audio simultaneously. By using the Network Camera’s built-in or external microphone and an external speaker, you can communicate with people around the Network Camera.

Note that as JPEG only transmits a series of JPEG images to the client, to enable the two-way audio function, make sure the video mode is set to “MPEG-4” on the Audio and Video Settings page and the media option is set to “Video and Audio” on the Client Settings page. Please refer to Client Settings on page 30 and Audio and Video Settings on page 61.



Audio is being transmitted to the Network Camera



Click  to enable audio transmission to the Network Camera; click  to adjust the volume of microphone; click  to turn off the audio. To stop talking, click  again.

FTP

FTP

FTP port:

The FTP server allows the user to save recorded video clips. You can utilize TOSHIBA Installation Wizard to upgrade the firmware via FTP server. By default, the FTP port is set to 21. It also can be assigned to another port number between 1025 and 65535.

RTSP Streaming

To utilize RTSP streaming authentication, make sure that you have set a password for the Network Camera first; please refer to Security on page 35 for details.

Authentication:	disable
Access name for stream 1:	live.sdp
Access name for stream 2:	live2.sdp
Access name for stream 3:	live3.sdp
Access name for stream 4:	live4.sdp
Access name for stream 5:	liveany.sdp
RTSP port:	554
RTP port for video:	5556
RTCP port for video:	5557
RTP port for audio:	5558
RTCP port for audio:	5559

Authentication: Depending on your network security requirements, the Network Camera provides three types of security settings for streaming via RTSP protocol: disable, basic, and digest.

If **basic** authentication is selected, the password is sent in plain text format, but there can be potential risks of it being intercepted. If **digest** authentication is selected, user credentials are encrypted using MD5 algorithm, thus providing better protection against unauthorized access.

Access name for stream 1 ~ 5: This Network camera supports multiple streams simultaneously. The access name is used to differentiate the streaming source.

If you want to use an **RTSP player** to access the Network Camera, you have to set the video mode to **MPEG-4** and use the following RTSP URL command to request transmission of the streaming data.

`rtsp://<ip address>:<rtsp port>/<access name for stream 1 ~ 5>`

For example, when the access name for **stream 1** is set to **live.sdp**:

1. Launch an RTSP player.
2. Choose File > Open URL. A URL dialog box will pop up.
3. Type the above URL command in the text box.
4. The live video will be displayed in your player.

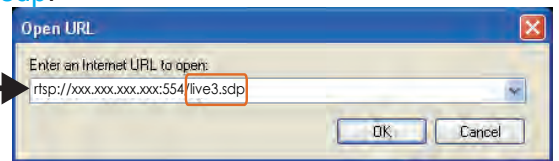

RTSP port /RTP port for video, audio/ RTCP port for video, audio

- RTSP (Real-Time Streaming Protocol) controls the delivery of streaming media. By default, the port number is set to 554.
- The RTP (Real-time Transport Protocol) is used to deliver video and audio data to the clients. By default, the RTP port for video is set to 5556 and the RTP port for audio is set to 5558.
- The RTCP (Real-time Transport Control Protocol) allows the Network Camera to transmit the data by monitoring the Internet traffic volume. By default, the RTCP port for video is set to 5557 and the RTCP port for audio is set to 5559.

The ports can be changed to values between 1025 and 65535. The RTP port must be an even number and the RTCP port is the RTP port number plus one, and thus is always an odd number. When the RTP port changes, the RTCP port will change accordingly.

If the RTP ports are incorrectly assigned, the following warning message will be displayed:

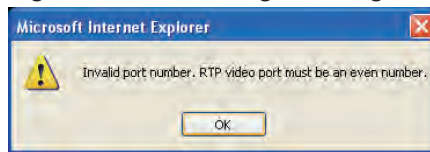

Multicast settings for stream 1 ~ 5: Click the items to display the detailed configuration information. Select the Always multicast option to enable multicast for stream 1 ~ 5.

▼ Multicast settings for stream 1:

Always multicast

Multicast group address:

Multicast video port:

Multicast RTCP video port:

Multicast audio port:

Multicast RTCP audio port:

Multicast TTL [1~255]:

▼ Multicast settings for stream 2:

Always multicast

Multicast group address:

Multicast video port:

Multicast RTCP video port:

Multicast audio port:

Multicast RTCP audio port:

Multicast TTL [1~255]:

Unicast video transmission delivers a stream through point-to-point transmission; multicast, on the other hand, sends a stream to the multicast group address and allows multiple clients to acquire the stream at the same time by requesting a copy from the multicast group address. Therefore, enabling multicast can effectively save Internet bandwidth.

The ports can be changed to values between 1025 and 65535. The multicast RTP port must be an even number and the multicast RTCP port number is the multicast RTP port number plus one, and thus is always odd. When the multicast RTP port changes, the multicast RTCP port will change accordingly.

If the multicast RTP video ports are incorrectly assigned, the following warning message will be displayed:

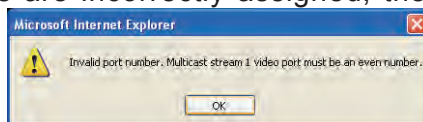

Multicast TTL [1~255]: The multicast TTL (Time To Live) is the value that tells the router the range a packet can be forwarded.

DDNS

This section explains how to configure dynamic domain name service for the Network Camera. DDNS is a service that allows your Network Camera, especially when assigned with a dynamic IP address, to have a fixed host and domain name.

DDNS: Dynamic domain name service



DDNS: Dynamic domain name service

Enable DDNS

Provider: No-IP.com

Host name:

User name:

Password:

Save

Enable DDNS: Select this option to enable the DDNS setting.

Provider: The provider list contains seven hosts that provide DDNS service. Please connect to the service provider's web site to review the service charges and sign-up for the service if you want to use DDNS.

ChangeIP.com

<http://www.changeip.com/toshiba/>

No-IP.com

<http://www.no-ip.com/ext/toshiba.php>

Host Name: If the User wants to use a DDNS service, enter the camera name that is registered at the DDNS server.

User Name: The User Name field is necessary for logging into the DDNS server or to notify the User of the new IP address.

Note: When this field is input as "User Name", the following field must be input as "Password".

Password: Input the password to access the DDNS service.

Save: Click on this button to save current settings for the DDNS service.

Access List Advanced Mode

This section explains how to control access permission by verifying the client PC's IP address.

General Settings

General Settings

Maximum number of concurrent streaming connection(s) limited to:

Enable access list filtering

Maximum number of concurrent streaming connection(s) limited to: Simultaneous live viewing for 1~10 clients (including stream 1 and stream 2). The default value is 10. If you modify the value and click **Save**, all current connections will be disconnected and automatically attempt to re-link.

View Information: Click this button to display the connection status window showing a list of the current connections. For example:

Connection status

	IP address	Elapsed time	User ID
<input type="checkbox"/>	192.168.1.147	12:20:34	root
<input type="checkbox"/>	61.22.15.3	00:10:09	
<input type="checkbox"/>	192.168.3.25	45:00:34	greg
<input type="checkbox"/>			
<input type="checkbox"/>			
<input type="checkbox"/>			
<input type="checkbox"/>			
<input type="checkbox"/>			

- IP address: Current connections to the Network Camera.
- Elapsed time: How much time the client has been at the webpage.
- User ID: If the administrator has set a password for the webpage, the clients have to enter a user name and password to access the live video. The user name will be displayed in the User ID column. If the administrator allows clients to link to the webpage without a user name and password, the User ID column will be empty.

There are some situations which allow clients access to the live video without a user name and password:

1. The administrator does not set up a root password. For more information about how to set up a root password and manage user accounts, please refer to Security on page 35.
2. The administrator has set up a root password, but set **RTSP Authentication** to “disable”. For more information about **RTSP Authentication**, please refer to RTSP Streaming on page 55.
3. The administrator has set up a root password, but allows anonymous viewing. For more information about **Allow Anonymous Viewing**, please refer to Security on page 35.

- Refresh: Click this button to refresh all current connections.
- Add to deny list: You can select entries from the Connection Status list and add them to the Deny List to deny access. Please note that those checked connections will only be disconnected temporarily and will automatically try to re-link again (IE Explore or Quick Time Player). If you want to enable the denied list, please check **Enable access list filtering** and click **Save** in the first column.
- Disconnect: If you want to break off the current connections, please select them and click this button. Please note that those checked connections will only be disconnected temporarily and will automatically try to re-link again.

Enable access list filtering: Check this item and click **Save** if you want to enable the access list filtering function.

Filter

There are two lists for permission control: Allowed list and Denied list. Only those clients whose IP addresses are on the Allowed list and not on the Denied list can access the Network Camera. Please note that the IPv6 access list column will not be displayed unless you enable IPv6 on the Network page. For more information about **IPv6 Settings**, please refer to page 46 for detailed information.

General Settings

Maximum number of concurrent streaming connection(s) limited to:

Enable access list filtering

Filter

IPv4 access list

<p>Allowed list</p> <div style="border: 1px solid #ccc; padding: 5px; min-height: 40px;">1.0.0.0-255.255.255.255</div> <p><input type="button" value="Add"/> <input type="button" value="Delete"/></p>	<p>Denied list</p> <div style="border: 1px solid #ccc; padding: 5px; min-height: 40px;"></div> <p><input type="button" value="Add"/> <input type="button" value="Delete"/></p>
---	---

IPv6 access list

<p>Allowed list</p> <div style="border: 1px solid #ccc; padding: 5px; min-height: 40px;">::/0</div> <p><input type="button" value="Add"/> <input type="button" value="Delete"/></p>	<p>Denied list</p> <div style="border: 1px solid #ccc; padding: 5px; min-height: 40px;"></div> <p><input type="button" value="Add"/> <input type="button" value="Delete"/></p>
--	---

- Add a rule to Allowed/Denied list: Click **Add** to add a rule to Allowed/Denied list.

There are three types of rules:

Single: This rule allows the user to add an IP address to the Allowed/Denied list.

For example:

filter address

Rule:

IP address:

Network: This rule allows the user to assign a network address and corresponding subnet mask to the Allow/Deny List.
For example:

filter address

Rule: **Network** ▾

Network address / Network mask /

IP address 192.168.2.x will be blocked.

Range: This rule allows the user to assign a range of IP addresses to the Allow/Deny List. This rule is only applied to IPv4.
For example:

filter address

Rule: **Range** ▾

IP address - IP address -

■ **Delete Allowed/Denied list:**

In the Delete Allowed List or Delete Denied List column, make a selection and click **Delete**.

NOTE

- For example, when the range of IP addresses on the allowed list is set from 1.1.1.0 to 192.255.255.255 and the range in the denied list is set from 1.1.1.0 to 170.255.255.255, only users' IPs between 171.0.0.0 and 192.255.255.255 can access the Network Camera.

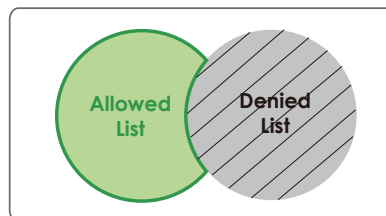

Administrator IP address

Always allow the IP address to access this device: You can check this item and add the Administrator's IP address in this field to make sure the Administrator can always connect to the device.

Administrator IP address

Always allow the IP address to access this device

Audio and Video

This section explains how to configure the audio and video settings of the Network Camera. It is composed of the following two columns: Video Settings and Audio Settings.

Video Settings

Video Settings

Video title:

Color: ▾

Power line frequency: ▾

Iris mode: ▾

Select caching stream: ▾

Video orientation: Flip Mirror

Overlay title and time stamp on video and snapshot.

Enable time shift caching stream

Video title: Enter a name that will be displayed on the title bar of the live video.

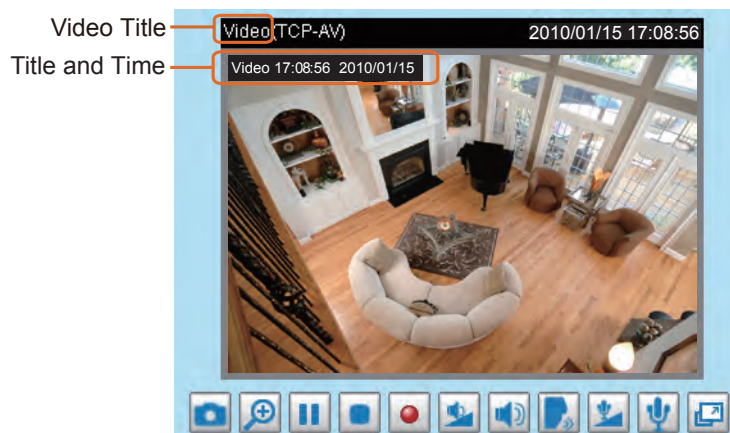

Color: Select to display color or black/white video streams.

Power line frequency: Set the power line frequency consistent with local utility settings to eliminate image flickering associated with fluorescent lights. Note that after the power line frequency is changed, you must disconnect and reconnect the power cord of the Network Camera in order for the new setting to take effect.

Iris mode: Select a proper iris mode for your environment.

- Fixed: Open the lens iris at any time. Exposure time will be controlled automatically for all use.
- Indoor: Lens iris and exposure time will be controlled automatically for indoor use.
- Outdoor: Lens iris and exposure time will be controlled automatically for outdoor use.

Select caching stream: This Network Camera supports time shift cache stream on the Network Camera. Select one stream and check the below option **Enable time shift caching stream**.

Enable time shift caching stream **Advanced Mode**: Check this item to enable the time shift cache stream on the Network Camera, which stores video in the camera's embedded memory for a period of time depending on the cache memory of each Network Camera.

Video orientation: Flip--vertically reflect the display of the live video; Mirror--horizontally reflect the display of the live video. Select both options if the Network Camera is installed upside-down (ex. on the ceiling) to correct the image orientation.

Overlay title and time stamp on video: Select this option to place the video title and time on the video streams. The time refers to System Time on page 34.

Note that when the frame size is set to 176 x 144 as shown in the picture below, only the time will be stamped on the video streams.

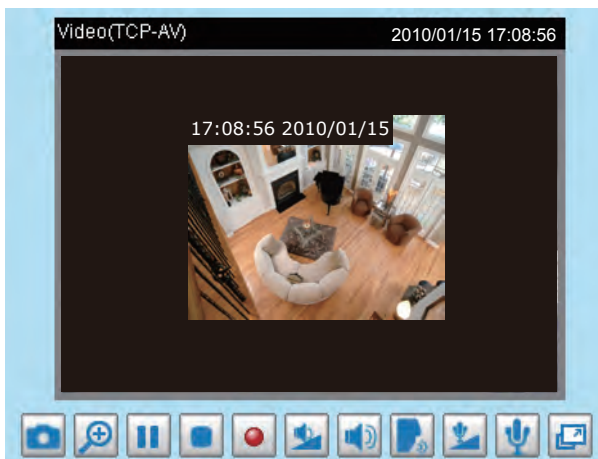

Options of Video **Advanced Mode**

There are three options for you to choose: Video Quality first, Video frame rate first, and Cropping mode. Select either one mode according to your needs.

Options of Video

- Video quality first (MAX 15fps)
 - Video frame rate first (Maximum frame size 800x600)
 - Cropping mode
-
- Video quality first: Select this option will reduce the maximum frame rate to 15fps and clear the settings in the Viewing Window.
 - Video frame rate first: Select this option will limit the frame size to 800x600 and clear the settings in the Viewing Windows.
 - Cropping mode: The cropping function allows users to crop unnecessary information and simply transmit the image of the target region for viewing or storage. With the trimming, the transmitting data size and thus, the network load is reduced and a higher frame rate is obtained. As a result, bandwidth resources and storage space can be used more efficiently.

Image Settings **Advanced Mode**

Click **Image settings** to open the Image Settings page. On this page, you can tune the White balance, Brightness, Saturation, Contrast, and Sharpness settings for the video.

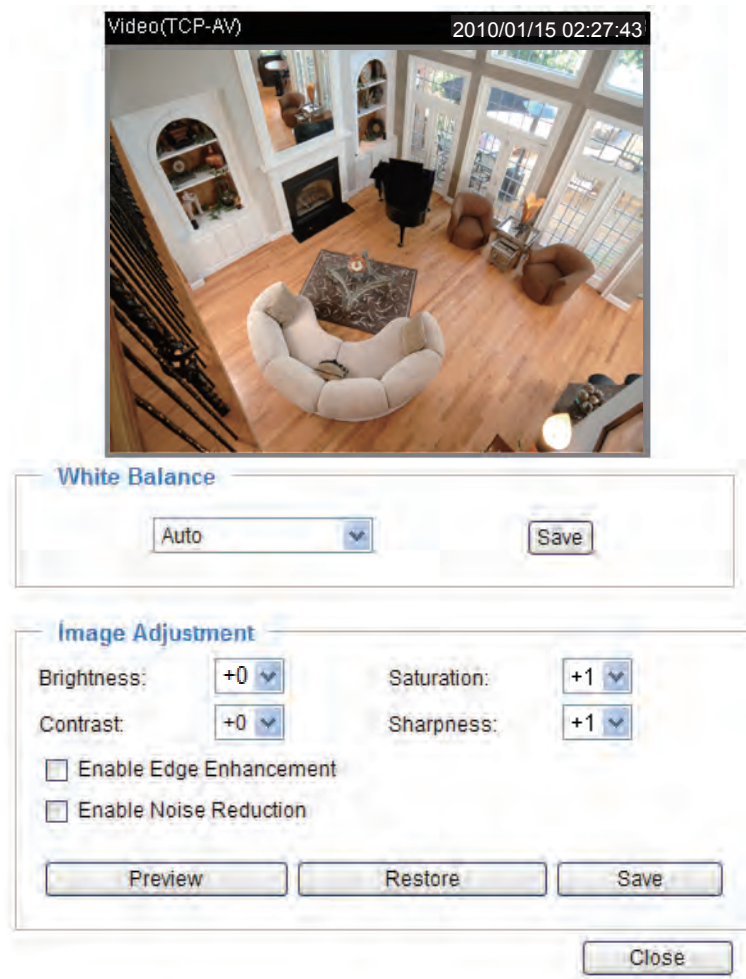

White balance: Adjust the value for the best color temperature.

■ **Auto**

The Network Camera automatically adjusts the color temperature of the light in response to different light sources. The white balance setting defaults to **Auto** and works well in most situations.

■ **Keep current value**

Follow the steps below to manually set the white balance to compensate for the ambient lighting conditions.

1. Set the White balance to **Auto** and click **Save**.
2. Place a sheet of white paper in front of the lens, then allow the Network Camera to adjust the color temperature automatically.
3. Select Keep Current Value to confirm the setting while the white balance is being measured.
4. Click **Save** to enable the new setting.

Image Adjustment

- **Brightness**: Adjust the image brightness level, which ranges from -5 to +5. The default value is set to 0.
- **Saturation**: Adjust the image saturation level, which ranges from -5 to +5. The default value is set to +1.
- **Contrast**: Adjust the image contrast level, which ranges from -5 to +5. The default value is set to 0.
- **Sharpness**: Adjust the image sharpness level, which ranges from -5 to +5. The default value is set to +1.

Enable Edge Enhancement

Edge enhancement is an image processing filter that enhances the edge contrast of an image or video to improve its sharpness. Enter a value from 1 to 128 to set the degree of enhancement desired.

Enable Edge Enhancement

Strength: (1~128)

Enable Noise Reduction

Noise reduction is the process of removing noise from a signal. Select the type of noise to remove and enter a value from 1 to 63 to set the degree of enhancement required.

Enable Noise Reduction

Remove Noise:

Strength: (1~63)

You can click **Preview** to fine-tune the image, or click **Restore** to recall the original settings without incorporating the changes. When completed with the settings on this page, click **Save** to enable the setting and click **Close** to exit the page.

Privacy Mask **Advanced Mode**

Click **Privacy Mask** to open the settings page. On this page, you can block out sensitive zones to address privacy concerns.

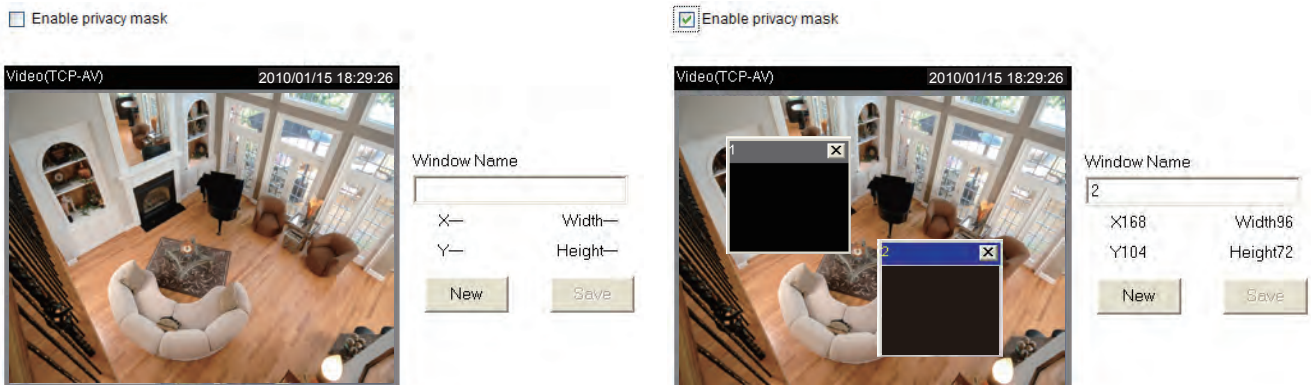

- To set the privacy mask windows, follow the steps below:
 1. Click **New** to add a new window.
 2. Use the mouse to size and drag-drop the window, which is recommended to be at least twice the size of the object (height and width) you want to cover.
 3. Enter a Window Name and click **Save** to enable the setting.
 4. Select **Enable privacy mask** to enable this function.

NOTE

- Up to 5 privacy mask windows can be set up on the same screen.
- If you want to delete the privacy mask window, please click the 'x' on the upper right-hand corner of the window.

Sensor Settings **Advanced Mode**

Click **Sensor Settings** to open the Image Sensor Settings page. On this page, you can set the maximum exposure time, exposure level, and AGC (Auto Gain Control) settings.

You can configure two sets of sensor settings: one for normal situations, the other for special situations, such as day/night/schedule mode.



Exposure

Maximum Exposure Time:	1/30 S
Exposure level:	-1
Max gain:	4X
<input type="checkbox"/> Enable BLC	

Profile

Preview Restore Save Close

Sensor Setting 1:
For normal situations

Sensor Setting 2:
For special situations

Exposure

- **Maximum Exposure Time:** Select a proper maximum exposure time according to the light source of the surroundings. The exposure times are selectable for the following durations: 1/120 second, 1/90 second, 1/30 second, 1/15 second, and 1/5 second. Shorter exposure times result in less light.
- **Exposure level:** You can manually set the Exposure level, which ranges from 1 to 8 (dark to bright). The default value is -1.
- **Max gain:** You can manually set the AGC level (2X 4X, or 8X). The default value is 4X.
- **Enable BLC (Back Light Compensation):** Enable this option when the object is too dark or too bright to recognize. It allows the camera to adjust to the best light conditions in any environment and automatically give the necessary light compensation.

You can click **Preview** to fine-tune the image, or click **Restore** to recall the original settings without incorporating the changes. When completed with the settings on this page, click **Save** to enable the settings and click **Close** to exit the page.

If you want to configure another sensor setting for day/night/schedule mode, please click **Profile** to open the Sensor Settings Profile Settings page as shown below.

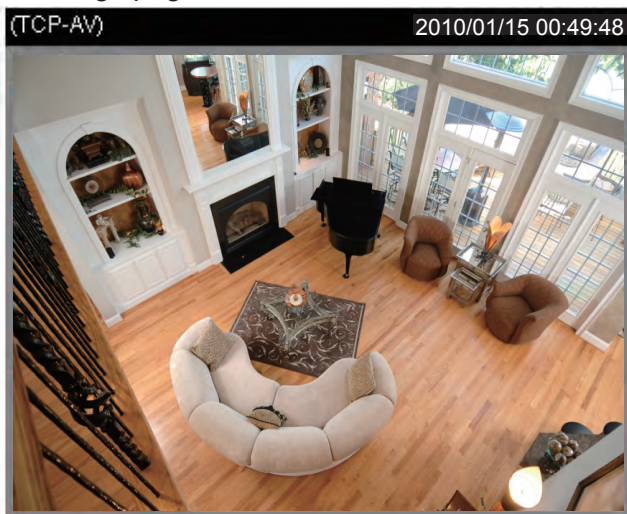

General Settings

Enable this profile

This profile is applied to

Day mode

Night mode

Schedule mode:

Exposure

Maximum Exposure Time:

1/5 S ▾

Exposure level:

4 ▾

Enable AGC:

8X ▾

Enable BLC

Preview

Restore

Save

Close

Please follow the steps below to setup a profile:

1. Check **Enable this profile**.
2. Select the applied mode: Day mode, Night mode, or schedule mode. Please manually enter a range of time if you choose Schedule mode.
3. Configure Exposure settings in the second column. Please refer to last page for detailed information.
4. Click **Save** to enable the setting and click **Close** to exit the page.

Viewing Window **Advanced Mode**

This Network Camera supports multiple streams with frame size ranging from 176 x 144 to 1600 x 1200.

The definition of multiple streams:

- Stream 1: Users can define the "Region of Interest" (viewing region) and the "Output Frame Rate" (size of the live view window).
- Stream 2: Users can define the "Region of Interest" (viewing region) and the "Output Frame Rate" (size of the live view window)
- Stream 3: (Mobile stream): Users can define the "Region of Interest" (viewing region), but the "Output Frame Rate" (size of the live view window) is fixed at 176 x 144.
- Stream 4: (Global view stream): This stream captures the full view of the video and streams out at the maximum resolution (1600 x 1200).

TOSHIBA **Network Camera**

Video Stream 1
Digital Output On Off

Zoom

Pan Stop Patrol

Pan speed 0
Tilt speed 0
Zoom speed 0

Global View

Moving Instantly

Client Settings
Configuration

(TCP-AV) 2010/09/01 11:21:20

Output Frame Size
(Size of the Live View Window)

NOTE

- All the items in the "Region of Interest" should not be greater than the "Output Frame Size" (current maximum resolution).

Click **Viewing Window** to open the viewing region settings page. On this page, you can set the **Region of Interest** and the **Output Frame Size** for stream 1 ~ 3.

Please follow the steps below to set up those settings for a stream:

1. Select a stream which you want to set up the viewing region. If you want to stream out the video to a mobile device, please select stream 3.
2. Select a **Region of Interest** from the drop-down list. The floating frame, the same as the one in the Gloabl View window on the home page, will resize accordingly. If you want to set up a customized viewing region, you can also resize and drag the floating frame to a desired position with your mouse.
3. Choose a proper **Output Frame Size** from the drop-down list according to the size of your monitoring device.

■ The parameters of the multiple streams:

	Region of Interest	Output frame size
Stream 1	1600 X 1200 ~ 176 x 144 (Selectable)	1600 X 1200 ~ 176 x 144 (Selectable)
Stream 2	1600 X 1200 ~ 176 x 144 (Selectable)	1600 X 1200 ~ 176 x 144 (Selectable)
Stream 3	1600 x 1200 ~ 176 x 144 (Selectable)	176 x 144 (Fixed)
Stream 4	1600 X 1200 (Fixed)	1600 X 1200 (Selectable)

■ The maximum **Region of Interest** of stream 3 is 1600 x 1200. However, the image will be distorted a little bit. If you remove the check of "Set region to full view" , the maximum region of interest become 1456 x 1200.

When completed with the settings in the Viewing Window, click **Save** to enable the settings and click **Close** to exit the window. The selected **Output Frame Size** will immediately be applied to the **Frame size** of each video stream as shown on the next page. Then you can go back to the home page to test the e-PTZ function. For more information about the e-PTZ function, please refer to page 81.

Cropping Setting **Advanced Mode**

Click **Cropping Setting** to open the Cropping Settings page.

Please follow the steps below to set up cropping mode for multiple streams:

1. Click **Cropping Setting** to open the window as shown below.
2. Select a **Captured area** from the drop-down list. The floating frame, the same as the one in the Global View window on the home page, will resize accordingly. If you want to set up a customized viewing region, you can also resize and drag the floating frame to a desired position with your mouse.

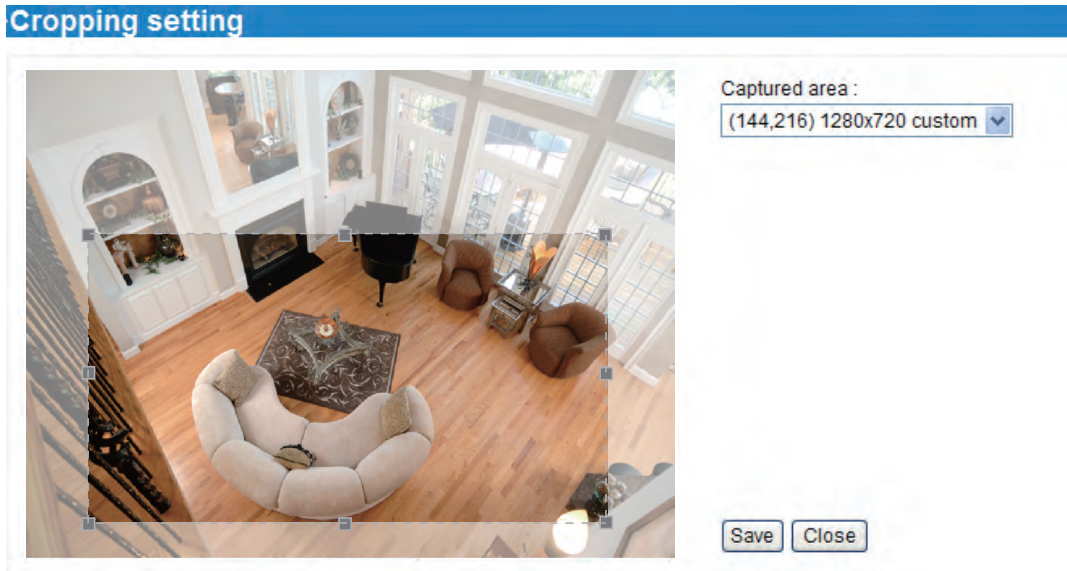

3. Click **Save** to enable the settings and click **Close** to exit the window. Below is the illustration of cropped image:

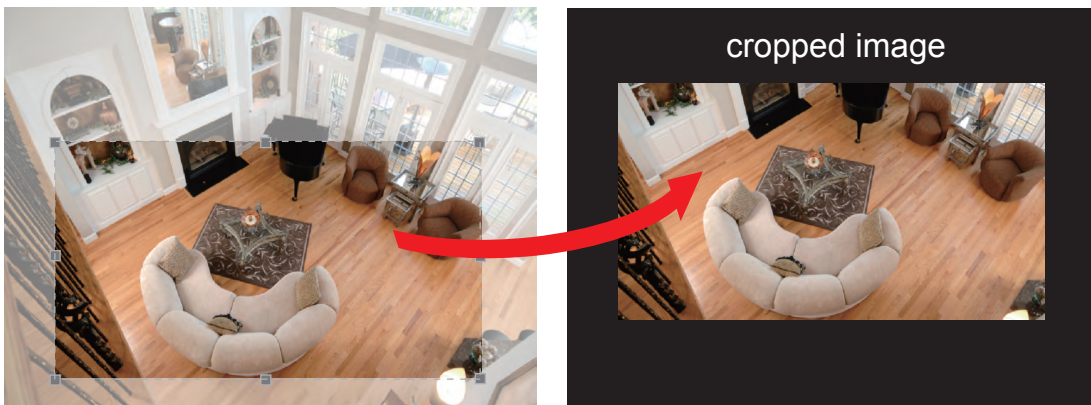

NOTE

- In cropping mode, the maximum frame rate will be up to 30fps if the width is under 1280 and the height is under 720; otherwise, the maximum frame rate may be reduced to 15fps.
- Select cropping mode will clear the settings in the Viewing Window and disable Motion Detection, Privacy Mask, and Preset Position.

Video quality settings for stream 1 ~ 4 **Advanced Mode**

Click the items to display the detailed video quality settings.

The selections of frame sizes will be listed according to your settings in the Viewing Window.

Video quality settings for stream 1:

MPEG-4: selectable

Frame size:

Maximum frame rate:

Intra frame period:

Video quality:

Constant bit rate:

Fixed quality:

JPEG:

Video quality settings for stream 3:

MPEG-4: fixed

Frame size:

Maximum frame rate:

Intra frame period:

Video quality:

Constant bit rate:

Fixed quality:

JPEG:

Video quality settings for stream 2:

MPEG-4:

JPEG: selectable

Frame size:

Maximum frame rate:

Video quality:

Video quality settings for stream 4:

MPEG-4: selectable

Frame size:

Maximum frame rate:

Intra frame period:

Video quality:

Constant bit rate:

Fixed quality:

JPEG:

This Network Camera offers two choices of video compression standards (MPEG-4 and JPEG) for real-time viewing.

If **MPEG-4** mode is selected, the video is streamed via RTSP protocol. There are four parameters provided in MPEG-4 mode which allow you to adjust the video performance:

MPEG-4:

Frame size:

Maximum frame rate:

Intra frame period:

Video quality:

Constant bit rate:

Fixed quality:

■ **Frame size**

You can set up different video resolution for different viewing devices. For example, set a smaller frame size and lower bit rate for remote viewing on mobile phones and a larger video size and a higher bit rate for live viewing on web browsers. Note that a larger frame size takes up more bandwidth.

■ **Maximum frame rate**

This limits the maximum refresh frame rate per second. Set the frame rate higher for smoother video quality.

If the power line frequency is set to 50Hz, the frame rates are selectable at 1fps, 2fps, 3fps, 5fps, 8fps, 10fps, 15fps, 20fps, and 25fps. If the power line frequency is set to 60Hz, the frame rates are selectable at 1fps, 2fps, 3fps, 5fps, 8fps, 10fps, 15fps, 20fps, 25fps, and 30fps. You can also select **Customize** and manually enter a value. The frame rate will decrease if you select a higher resolution.

■ **Intra frame period**

Determine how often to plant an I frame. The shorter the duration, the more likely you will get better video quality, but at the cost of higher network bandwidth consumption. Select the intra frame period from the following durations: 1/4 second, 1/2 second, 1 second, 2 seconds, 3 seconds, and 4 seconds.

■ **Video quality**

A complex scene generally produces a larger file size, meaning that higher bandwidth will be needed for data transmission. Therefore, if **Constant bit rate** is selected, the bandwidth utilization is fixed at a selected level, resulting in mutable video quality performance. The bit rates are selectable at the following rates: 20Kbps, 30Kbps, 40Kbps, 50Kbps, 64Kbps, 128Kbps, 256Kbps, 512Kbps, 768Kbps, 1Mbps, 2Mbps, 3Mbps, and 4Mbps. You can also select **Customize** and manually enter a value.

On the other hand, if **Fixed quality** is selected, all frames are transmitted with the same quality; bandwidth utilization is therefore unpredictable. The video quality can be adjusted to the following settings: Acceptable, Satisfactory, Good, Very Good, and Excellent. You can also select **Customize** and manually enter a value from 1 (high quality) to 31 (low quality).

If **JPEG** mode is selected, the Network Camera continuously sends JPEG images to the client, producing a moving effect similar to a filmstrip. Every single JPEG image transmitted guarantees the same image quality, which in turn comes at the expense of variable bandwidth usage. Because the media contents are a combination of JPEG images, no audio data is transmitted to the client. There are three parameters provided in MJPEG mode to control the video performance:

JPEG:

Frame size:	1600x1200
Maximum frame rate:	15 fps
Video quality:	Good

■ **Frame size**

You can set up different video resolution for different viewing devices. For example, set a smaller frame size and lower bit rate for remote viewing on mobile phones and a larger video size and a higher bit rate for live viewing on web browsers. Note that a larger frame size takes up more bandwidth.

■ **Maximum frame rate**

This limits the maximum refresh frame rate per second. Set the frame rate higher for smoother video quality.

If the power line frequency is set to 50Hz, the frame rates are selectable at 1fps, 2fps, 3fps, 5fps, 8fps, 10fps, 15fps, 20fps, and 25fps. If the power line frequency is set to 60Hz, the frame rates are selectable at 1fps, 2fps, 3fps, 5fps, 8fps, 10fps, 15fps, 20fps, 25fps, and 30fps. You can also select **Customize** and manually enter a value. The frame rate will decrease if you select a higher resolution.

■ Video quality

The video quality can be adjusted to the following settings: Acceptable, Satisfactory, Good, Very Good, and Excellent. You can also select **Customize** and manually enter a value from 10 (high quality) to 200 (low quality).

NOTE

- *Video quality and fixed quality refers to the **compression rate**, so a lower value will produce higher quality.*

Day/Night Settings

▼ Day/Night settings:

Switch to B/W in night mode

IR cut filter:

Light sensor sensitivity:

Switch to B/W in night mode

Select this to enable the Network Camera to automatically switch to B/W during night mode.

IR cut filter

With a removable IR-cut filter, this Network Camera can automatically remove the filter to let IR light into the sensor during low light conditions.

■ Auto mode

The Network Camera automatically removes the filter by judging the level of ambient light.

■ Day mode

In day mode, the Network Camera switches on the IR cut filter at all times to block infrared light from reaching the sensor so that the colors will not be distorted.

■ Night mode

In night mode, the Network Camera switches off the IR cut filter at all times for the sensor to accept infrared light, thus helping to improve low light sensitivity.

■ Synchronize with digital input

The Network Camera automatically removes the IR cut filter when DI triggers.

■ Schedule mode

The Network Camera switches between day mode and night mode based on a specified schedule. Enter the start and end time for day mode. Note that the time format is [hh:mm] and is expressed in 24-hour clock time. By default, the start and end time of day mode are set to 07:00 and 18:00.

Light sensor sensitivity

Select Low, Normal, or High sensitivity for the light sensor.

Audio Settings

Audio Settings

Mute

External microphone input: 0 dB

Audio type:

AAC:

GSM-AMR:

GSM-AMR bit rate: 12.2 Kbps

Mute: Select this option to disable audio transmission from the Network Camera to all clients. Note that if mute mode is turned on, no audio data will be transmitted even if audio transmission is enabled on the Client Settings page. In that case, the following message is displayed:

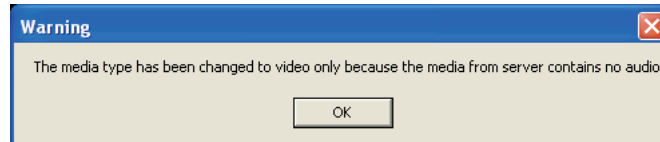

Internal microphone input gain: Select the gain of the internal audio input according to ambient conditions. Adjust the gain from +21 db (most sensitive) ~ -33 db (least sensitive).

External microphone input: Select the gain of the external audio input according to ambient conditions. Adjust the gain from +21 db (most sensitive) or -33 db (least sensitive).

Audio type: Select audio codec AAC or GSM-AMR and the bit rate **Advanced Mode**.

- AAC provides good sound quality at the cost of higher bandwidth consumption. The bit rates are selectable from: 16Kbps, 32Kbps, 48Kbps, 64Kbps, 96Kbps, and 128Kbps.
- GSM-ARM is designed to optimize speech quality and requires less bandwidth. The bit rates are selectable from: 4.75Kbps, 5.15Kbps, 5.90Kbps, 6.7Kbps, 7.4Kbps, 7.95Kbps, 10.2Kbps, and 12.2Kbps.

When completed with the settings on this page, click **Save** to enable the settings.

Motion Detection

This section explains how to configure the Network Camera to enable motion detection. A total of three motion detection windows can be configured.



Motion Detection Setting 1:
For normal situations

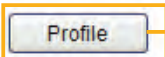

Motion Detection Setting 2:
For special situations

Follow the steps below to enable motion detection:

1. Click **New** to add a new motion detection window.
2. In the Window Name text box, enter a name for the motion detection window.
 - To move and resize the window, drag and drop your mouse on the window.
 - To delete window, click X on the top right corner of the window.
3. Define the sensitivity to moving objects and the space ratio of all alerted pixels by moving the Sensitivity and Percentage slider bar.
4. Click **Save** to enable the settings.
5. Select **Enable motion detection** to enable this function.

For example:

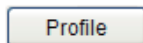

The Percentage Indicator will rise or fall depending on the variation between sequential images. When motions are detected by the Network Camera and are judged to exceed the defined threshold, the red bar rises. Meanwhile, the motion detection window will be outlined in red. Photos or videos can be captured instantly and configured to be sent to a remote server (Email, FTP) by utilizing this feature as a trigger source. For more information on how to set an event, please refer to Application on page 85.

A green bar indicates that even though motions have been detected, the event has not been triggered because the image variations still fall under the defined threshold.

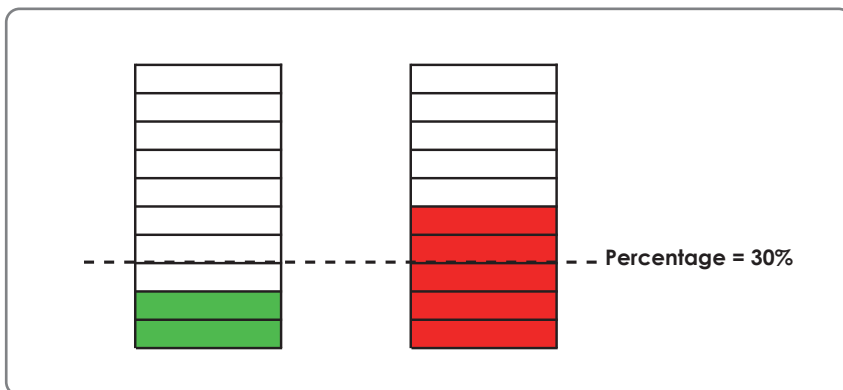

If you want to configure other motion detection settings for day/night/schedule mode, please click **Profile** to open the Motion Detection Profile Settings page as shown below. A total of three motion detection windows can be configured on this page as well.

The screenshot shows the Motion Detection Profile Settings page. The top section displays a video feed of a living room with a timestamp of 2010/01/15 14:59:09. Below the video are settings for Window Name, Sensitivity (0%), and Percentage (0%). There are "New" and "Save" buttons. The bottom section is titled "General Settings" and includes a checkbox for "Enable this profile" and radio buttons for "Day mode", "Night mode", and "Schedule mode". There is a "Save" button at the bottom right and a "Close" button at the bottom center.

Please follow the steps below to set up a profile:

1. Create a new motion detection window.
2. Check **Enable this profile**.
3. Select the applicable mode: Day mode, Night mode, or Schedule mode. Please manually enter a time range if you choose Schedule mode.
4. Click **Save** to enable the settings and click **Close** to exit the page.

This motion detection window will also be displayed on the Event Settings page. You can go to Application > Event Settings > Trigger to choose it as a trigger source. Please refer to page 87 for detailed information.

NOTE

- How does motion detection work?

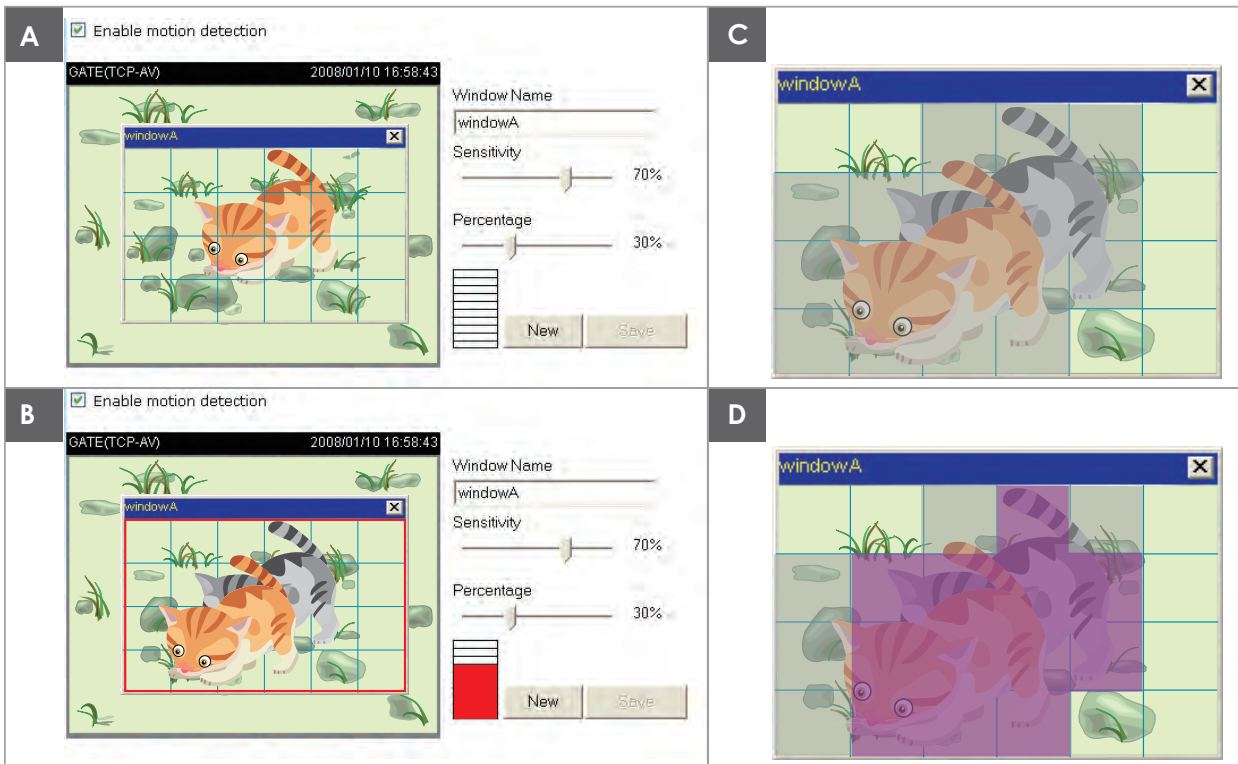

There are two motion detection parameters: Sensitivity and Percentage. In the illustration above, frame A and frame B are two sequential images. Pixel differences between the two frames are detected and highlighted in gray (frame C) and will be compared with the sensitivity setting. Sensitivity is a value that expresses the sensitivity to moving objects. Higher sensitivity settings are expected to detect slight movements while smaller sensitivity settings will neglect them. When the sensitivity is set to 70%, the Network Camera defines the pixels in the purple areas as “alerted pixels” (frame D).

Percentage is a value that expresses the proportion of “alerted pixels” to all pixels in the motion detection window. In this case, 50% of pixels are identified as “alerted pixels”. When the percentage is set to 30%, the motions are judged to exceed the defined threshold; therefore, the motion window will be outlined in red.

For applications that require a high level of security management, it is suggested to use higher sensitivity settings and smaller percentage values.

Camera Tampering Detection

This section explains how to set up camera temper detection. With tamper detection, the camera is capable of detecting incidents such as **redirection, blocking or defocusing**, or even **spray paint**.

Camera tampering detection

Enable camera tampering detection

Trigger duration: seconds [10~600]

Please follow the steps below to set up the camera tamper detection function:

1. Check **Enable camera tampering detection**.
2. Enter the tamper trigger duration. (10 sec. ~ 10 min.) The tamper alarm will be triggered only when the tampering factor (the difference between current frame and pre-saved background) exceeds the trigger threshold.
3. Set up the event source as Camera Tampering Detection on **Application page > Event Settings / Server Settings (how to send alarm message) / Media Settings (send what type of alarm message)**. Please refer to page 85 for detailed information.

Camera Control

This section explains how to control the Network Camera's Pan/Tilt/Zoom operation. It allows users to quickly move the focus to a target area for close-up viewing without moving the camera physically.

Select stream : 1



Pan speed
 Tilt speed
 Zoom speed
 Auto pan/patrol speed

Patrol settings

Preset locations	Selected locations	
	Source	Dwelling time
<input type="button" value="Select"/>	<input type="button" value="Remove"/> <input type="button" value="Up"/> <input type="button" value="Down"/>	<input type="text" value="10"/> <input type="button" value="Update"/>

Preset position name

 Preset Position

Select Stream: Select one of the stream 1~3 to set up the e-PTZ control. Please note that each stream can be set up with its own e-preset positions and e-patrol settings. For detailed information about how to set up **E-Preset Positions** and **E-Patrol Settings**, please refer to page 79~80.

When completed with the settings of e-PTZ, click Save to enable the settings on this page.

E-Preset Positions

A total of 20 preset positions can be configured. You can select preset positions for the camera to patrol.

Please follow the steps below to preset a position:

1. Adjust the shooting area to the desired position using the buttons on the right side of the window.
2. Enter a name for the preset position, which allows for up to forty characters. Click **Add** to enable the settings. The preset positions will be displayed under the Preset Location list on the left-hand side.
3. To add additional preset positions, please repeat steps 1~2.
4. To remove a preset position from the list, select it from the drop-down list and click **Delete**.
5. The e-preset positions will also be displayed on the main page. Please refer to the illustration on page 81.
6. Click **Save** to enable the settings.

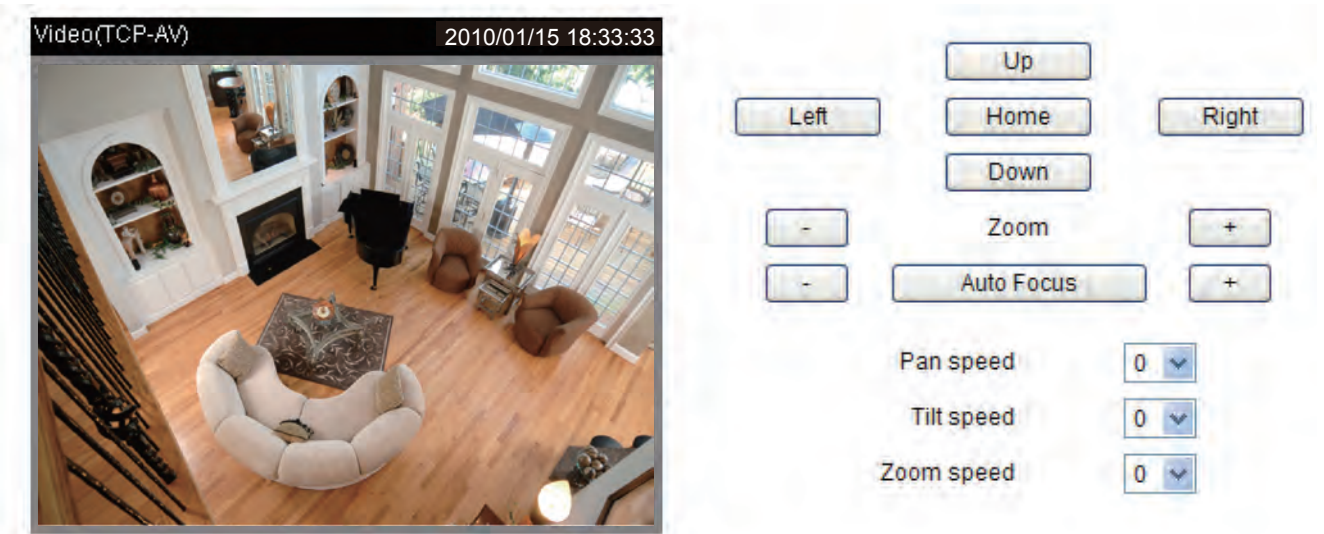

Patrol selection:

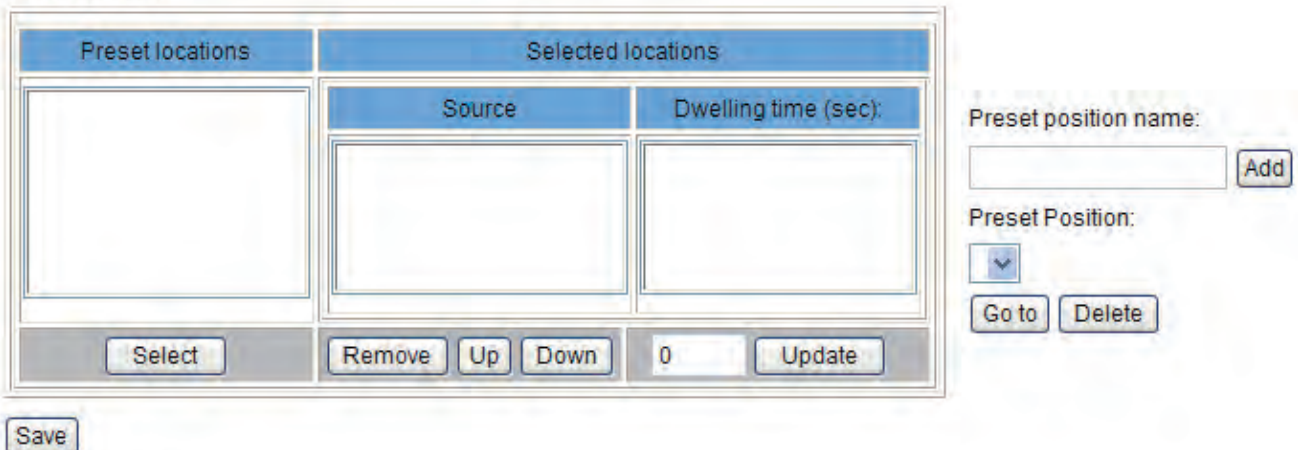

E-Patrol Settings

You can select some preset positions for the Network Camera to patrol.

Please follow the steps below to set up a patrol schedule:

1. Click a preset location on the list and click **Select**.
2. The selected preset location will be displayed on the **Source** list.
3. Set the **Dwelling time** for the preset location during auto patrol. You can also manually enter a value in the blank and click **Update**.
4. Repeat step 1 and 3 to select additional preset locations.
5. If you want to delete a selected location, select it from the Source list and click **Remove**.
6. Select a location and click **Up** or **Down** to rearrange the patrol order.
7. Click **Save** to enable the settings.



Control panel for camera movement and settings:

- Up
- Left
- Home
- Right
- Down
-
- Zoom
- +
-
- Auto Focus
- +
- Pan speed: 0
- Tilt speed: 0
- Zoom speed: 0

Patrol selection:

Preset locations	Selected locations	
up right down left	Source	Dwelling time (sec):
	right	10
	left	10
Select	Remove	Up
	Down	10
		Update

Preset position name:

 Add

Preset Position:

Save

Close

Home page in E-PTZ Mode

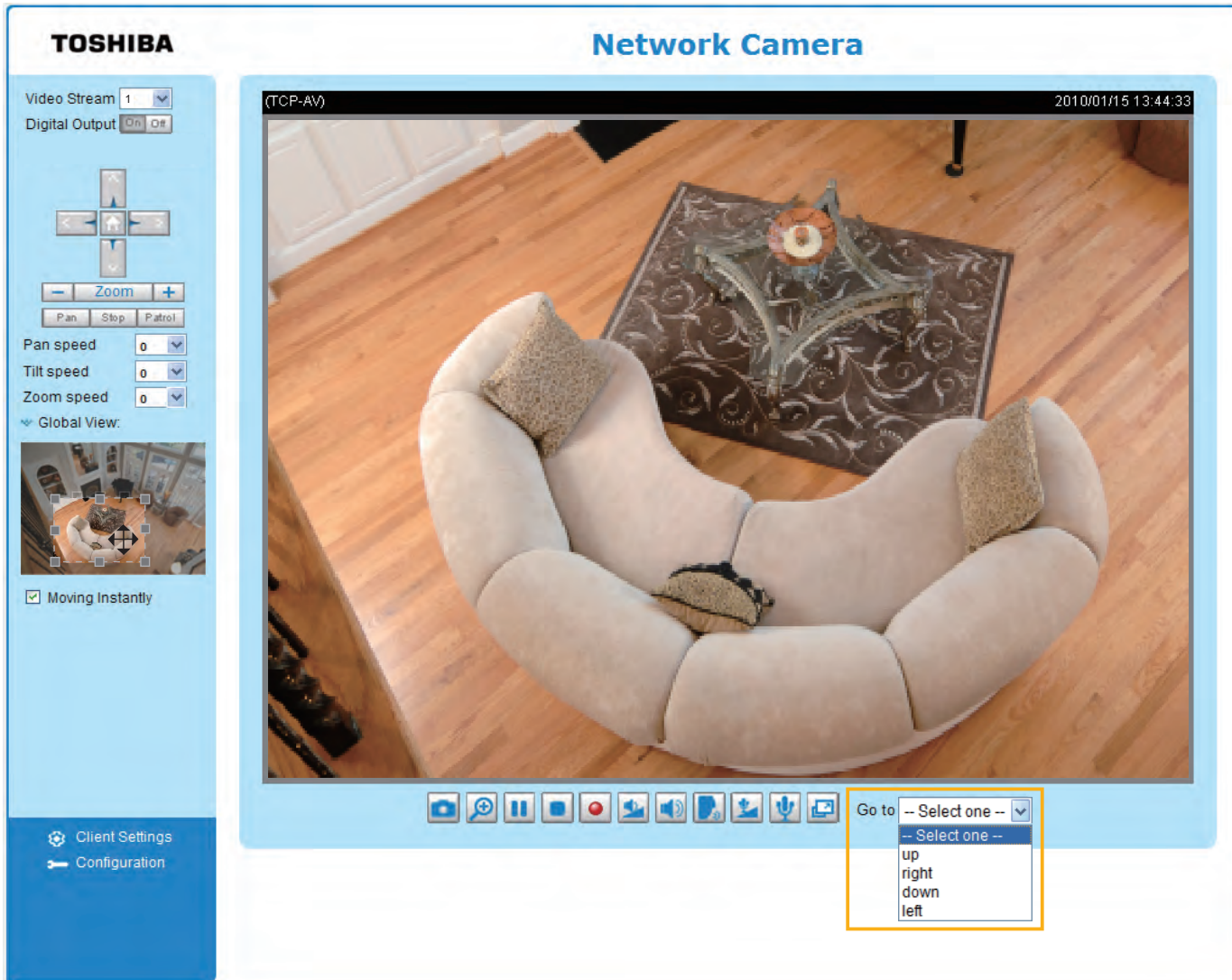

- The e-Preset Positions will also be displayed on the home page. Select one from the drop-down list, and the Network Camera will move to the selected e-preset position.
- If you have set up different e-preset positions for stream 1~3, you can select one of the video streams to display its separate e-preset positions.

Global View

In addition to using the e-PTZ control panel, you can also use the mouse to drag or resize the floating frame to pan/tilt/zoom the viewing region. The live view window will also move to the viewing region accordingly.

Moving Instantly

If you check this item, the live view window will switch to the new viewing region instantly after you move the floating frame.

Click on Image

The e-PTZ function also supports "Click on Image". When you click on any point of the Global View Window or Live View Window, the viewing region will also move to that point.

Homepage Layout Advanced Mode

This section explains how to set up your own customized homepage layout.

Preview

This column shows the settings of your homepage layout. You can manually select the background and font colors in Theme Options (the third column on this page). The settings will be displayed automatically in this Preview field. The following shows the homepage using the default settings:



Logo

Here you can change the logo at the top of your homepage.

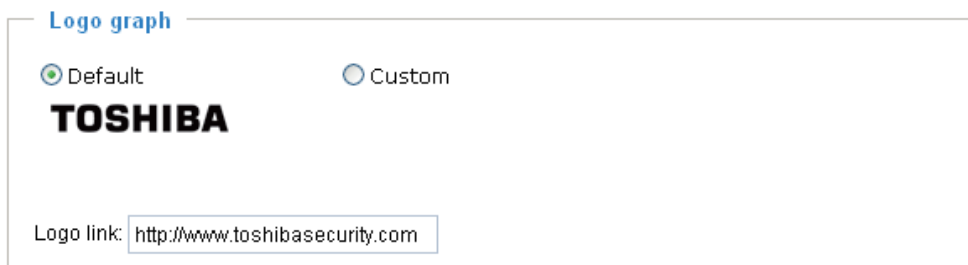

Follow the steps below to upload a new logo:

1. Click **Custom** and the Browse field will appear.
2. Select a logo from your files.
3. Click **Upload** to replace the existing logo with a new one.
4. Enter a website link if necessary.
5. Click **Save** to enable the settings.

Theme Options

Here you can change the color of your homepage layout. There are three types of preset patterns for you to choose from. The new layout will simultaneously appear in the **Preview** filed. Click **Save** to enable the settings.

Theme Options

Themes







Custom

Color:

Font color:

Font color of configuration area:

Font color of video title:

Bk color of control area:

Bk color of configuration area:

Bk color of video area:

Frame color:

Preview

TOSHIBA

Video Stream: 1

Digital Output: On Off

Client Settings

Network Camera



Annotations for the first preview:

- Font Color (points to 'TOSHIBA')
- Background Color of the Control Area (points to 'Digital Output')
- Font Color of the Configuration Area (points to 'Client Settings')
- Background Color of the Configuration Area (points to 'Client Settings')
- Font Color of the Video Title (points to 'Network Camera')
- Background Color of the Video Area (points to the camera view)
- Frame Color (points to the border of the camera view)

Preview

TOSHIBA

Video Stream: 1

Digital Output: On Off

Client Settings

Network Camera



Preview

TOSHIBA

Video Stream: 1

Digital Output: On Off

Client Settings

Network Camera



- Follow the steps below to set up the customized homepage:
 - Click **Custom** on the left column.
 - Click the field where you want to change the color on the right column.

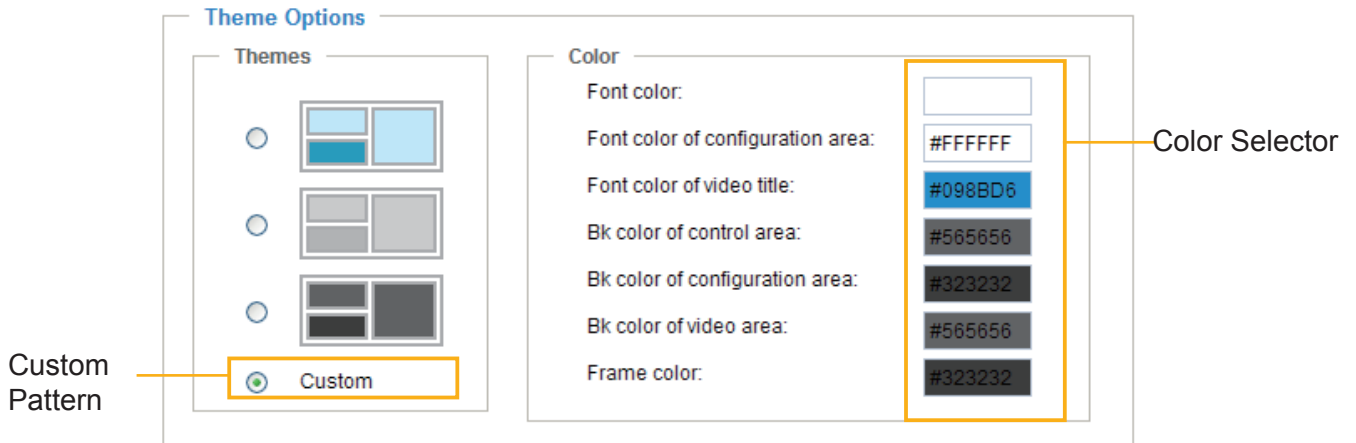

- The palette window will pop up as shown below.

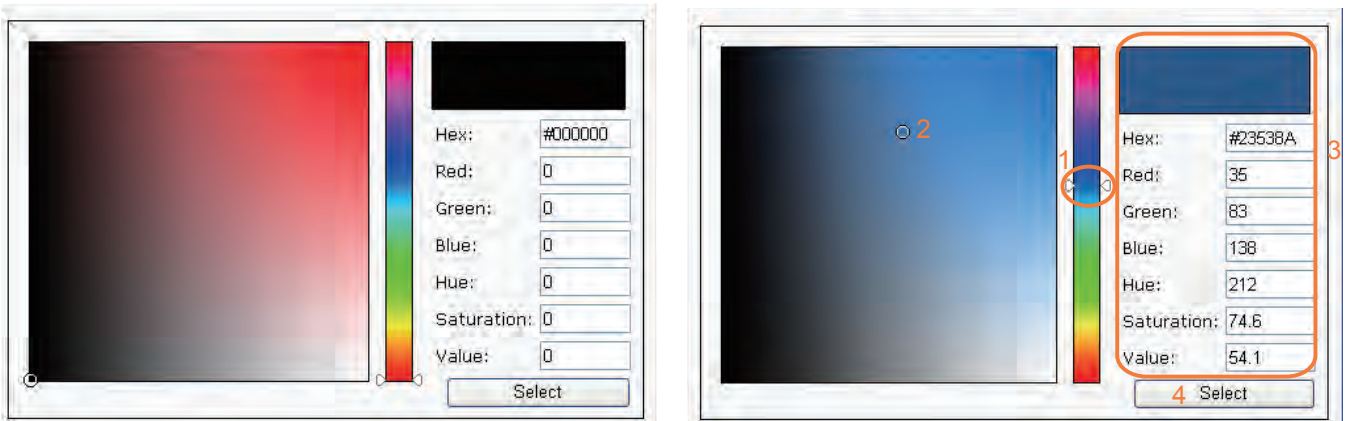

- Drag the slider bar and click on the left square to select a desired color.
- The selected color will be displayed in the corresponding fields and in the **Preview** column.
- Click **Save** to enable the settings.

Application Advanced Mode

This section explains how to configure the Network Camera to respond to particular situations (event). A typical application is that when a motion is detected, the Network Camera sends buffered images to an FTP server or e-mail address as notifications.

In the illustration on the right, an event can be triggered by many sources, such as motion detection or external digital input devices. When an event is triggered, you can specify what type of action that will be performed. You can configure the Network Camera to send snapshots or videos to your email address or FTP site.

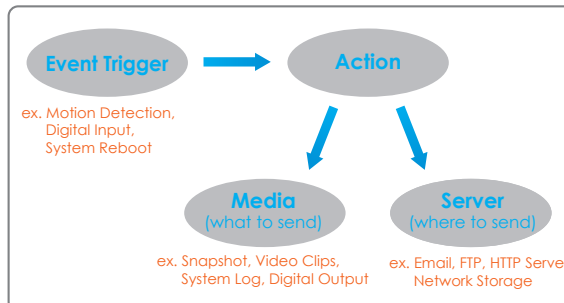

Event Settings

Name	Status	Sun	Mon	Tue	Wed	Thu	Fri	Sat	Time	Trigger
------	--------	-----	-----	-----	-----	-----	-----	-----	------	---------

Event Settings

In the **Event Settings** column, click **Add** to open the **Event Settings** page. On this page, you can arrange three elements -- Trigger, Schedule, and Action to set an event. A total of 3 event settings can be configured.

Event name:

Enable this event

Priority:

Detect next event after second(s).

Note: This can only applied to motion detection and digital input

Trigger

- Video motion detection
- Periodically
- Digital input
- System boot
- Recording notify
- Camera tampering detection

Event Schedule

Sun Mon Tue Wed Thu Fri Sat

Time

- Always
- From to [hh:mm]

Action

- Trigger digital output for seconds
 - Turn on IR illuminators for seconds
- in low-light conditions

Server	Media	Extra parameter
<input type="checkbox"/> SD	<input type="text" value="----None----"/>	<input type="button" value="SD Test"/> <input type="button" value="View"/>
<input type="checkbox"/> FTP	<input type="text" value="----None----"/>	

Event name: Enter a name for the event setting.

Enable this event: Select this option to enable the event setting.

Priority: Select the relative importance of this event (High, Normal, or Low). Events with a higher priority setting will be executed first.

Detect next event after seconds: Enter the duration in seconds to pause motion detection after a motion is detected.

An event is an action initiated by a user-defined trigger source; it is the causal arrangement of the following three elements: Trigger, Event Schedule, and Action.

Trigger

This is the cause or stimulus which defines when to trigger the Network Camera. The trigger source can be configured to use the Network Camera's built-in motion detection mechanism or external digital input devices.

There are several choices of trigger sources as shown below. Select the item to display the detailed configuration options.

■ Video motion detection

This option makes use of the built-in motion detection mechanism as a trigger source. To enable this function, you need to configure a Motion Detection Window first. For more information, please refer to Motion Detection on page 74 for details.

The screenshot shows a configuration window titled "Trigger". The "Video motion detection:" option is selected with a radio button. Below it, there are two rows of checkboxes: "Normal:" with checkboxes for 1, 2, and 3; and "Profile:" with checkboxes for 1, 2, and 3. A note below these options reads: "Note: Please configure [Motion detection](#) first". Below the note are five unselected radio button options: "Periodically:", "Digital input", "System boot", "Recording notify", and "Camera tampering detection:".

■ Periodically

This option allows the Network Camera to trigger periodically for every other defined minute. Up to 999 minutes are allowed.

The screenshot shows a configuration window titled "Trigger". The "Periodically:" option is selected with a radio button. Below it, the text "Trigger every other" is followed by a text input field containing the number "1" and the word "minutes". Below this are five unselected radio button options: "Video motion detection:", "Digital input", "System boot", "Recording notify", and "Camera tampering detection:".

■ Digital input

This option allows the Network Camera to use an external digital input device or sensor as a trigger source. Depending on your application, there are many choices of digital input devices on the market which helps to detect changes in temperature, vibration, sound, and light, etc.

■ System boot

This option triggers the Network Camera when the power to the Network Camera is disconnected.

■ Camera tampering detection

This option allows the Network Camera to trigger when the camera detects that it is being tampered with. To enable this function, you need to configure the Tampering Detection option first. Please refer to page 77 for detailed information.

Trigger

- Video motion detection:
- Periodically:
- Digital input
- System boot
- Recording notify
- Camera tampering detection:

Note: Please configure [Camera tampering detection](#) first

Event Schedule

Specify the period for the event.

Event Schedule

Sun Mon Tue Wed Thu Fri Sat

Time

Always

From to [hh:mm]

■ Select the days of the week.

■ Select the recording schedule in 24-hr time format.

Action

Define the actions to be performed by the Network Camera when a trigger is activated.

Action

Trigger digital output for seconds

Turn on IR illuminators for seconds

in low-light conditions

	Server	Media	Extra parameter	
<input type="checkbox"/>	SD	-----None----- <input type="button" value="v"/>	<input type="button" value="SD Test"/>	<input type="button" value="View"/>
<input type="checkbox"/>	FTP	-----None----- <input type="button" value="v"/>		

■ Trigger digital output for seconds

Select this option to turn on the external digital output device when a trigger is activated. Specify the length of the trigger interval in the text box.

■ Move to preset location

Select this option, the Network Camera will move to the preset location when a trigger is activated. Please setup the preset locations first. Please refer to Preset Locations on page 79 for detailed information.

To set an event with recorded video or snapshots, it is necessary to configure the server and media settings so that the Network Camera will know what action to take (such as which server to send the media files to) when a trigger is activated.

■ Add Server / Add Media

Click **Add Server** to configure [Server Settings](#). For more information, please refer to Server Settings on page 91.

Click **Add Media** to configure [Media Settings](#). For more information, please refer to Media Settings on page 94.

Here is an example of the Event Settings page:

Event name:

Enable this event

Priority:

Detect next event after second(s).

Note: This can only be applied to motion detection and digital input

Trigger

- Video motion detection
- Periodically
- Digital input
- System boot
- Recording notify
- Camera tampering detection

Event Schedule

Sun Mon Tue Wed Thu Fri Sat

Time

Always

From To [hh:mm]

Action

Trigger digital output for seconds

Turn on IR illuminators for seconds

	Server	Media	Extra parameter	
<input type="checkbox"/>	SD	<input type="text" value="----None----"/>	<input type="button" value="SD Test"/>	<input type="button" value="View"/>
<input type="checkbox"/>	FTP	<input type="text" value="----None----"/>		
<input type="checkbox"/>	NAS	<input type="text" value="----None----"/>	<input type="checkbox"/> Create folders by date time and hour automatically	<input type="button" value="View"/>
<input type="checkbox"/>	Email	<input type="text" value="----None----"/>		
<input type="checkbox"/>	HTTP	<input type="text" value="----None----"/>		

When completed, click **Save** to enable the settings and click **Close** to exit Event Settings page. The new event settings / server settings / media settings will appear in the event drop-down list on the Application page.

Here is an example of the Application page with an event setting:

Event Settings

Name	Status	Sun	Mon	Tue	Wed	Thu	Fri	Sat	Time	Trigger
Event1	ON	V	V	V	V	V	V	V	00:00~24:00	di

Server Settings

Name	Type	Address/Location
FTP	ftp	ftp.abc.com
NAS	ns	\\192.168.5.122\nas
Email	email	mail.abc.com
HTTP	http	http://192.168.5.10/cgi-bin/upload.cgi

Media Settings

Available memory space: 8000KB

Name	Type
Snapshot	snapshot
Video Clip	videoclip
System log	systemlog

When the Event Status is **ON**, once an event is triggered by motion detection, the Network Camera will automatically send snapshots via e-mail.

If you want to stop the event trigger, you can click **ON** to turn it to **OFF** status or click **Delete** to remove the event setting.

To remove a server setting from the list, select a server name from the drop-down list and click **Delete**. Note that only when the server setting is not being applied to an event setting can it be deleted.

To remove a media setting from the list, select a media name from the drop-down list and click **Delete**. Note that only when the media setting is not being applied to an event setting can it be deleted.

Server Settings

Click **Add Server** on Event Settings page to open the Server Setting page. On this page, you can specify where the notification messages are sent when a trigger is activated. A total of 5 server settings can be configured.

Server name: Enter a name for the server setting.

Server Type

There are four choices of server types available: Email, FTP, HTTP, and Network storage. Select the item to display the detailed configuration options. You can configure either one or all of them.

Email: Select to send the media files via email when a trigger is activated.

Server name:

Server Type

Email:

Sender email address:

Recipient email address:

Server address:

User name:

Password:

Server port:

This server requires a secure connection (SSL)

FTP:

HTTP:

Network storage:

- Sender email address: Enter the email address of the sender.
- Recipient email address: Enter the email address of the recipient.
- Server address: Enter the domain name or IP address of the email server.
- User name: Enter the user name of the email account if necessary.
- Password: Enter the password of the email account if necessary.
- Server port: The default mail server port is set to 25. You can also manually set another port.

If your SMTP server requires a secure connection (SSL), check **This server requires a secure connection (SSL)**.

To verify if the email settings are correctly configured, click **Test**. The result will be shown in a pop-up window. If successful, you will also receive an email indicating the result.

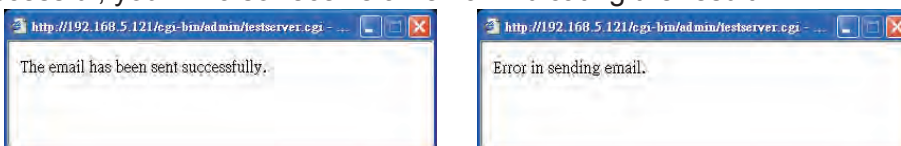

Click **Save** to enable the settings, then click **Close** to exit the page.

FTP: Select to send the media files to an FTP server when a trigger is activated.

Server name:

Server Type

Email:

FTP:

Server address:

Server port:

User name:

Password:

FTP folder name:

Passive mode

HTTP:

Network storage:

- **Server address:** Enter the domain name or IP address of the FTP server.
- **Server port**
By default, the FTP server port is set to 21. It can also be assigned to another port number between 1025 and 65535.
- **User name:** Enter the login name of the FTP account.
- **Password:** Enter the password of the FTP account.
- **FTP folder name**
Enter the folder where the media file will be placed. If the folder name does not exist, the Network Camera will create one on the FTP server.
- **Passive mode**
Most firewalls do not accept new connections initiated from external requests. If the FTP server supports passive mode, select this option to enable passive mode FTP and allow data transmission to pass through the firewall.

To verify if the FTP settings are correctly configured, click **Test**. The result will be shown in a pop-up window as shown below. If successful, you will also receive a test.txt file on the FTP server.

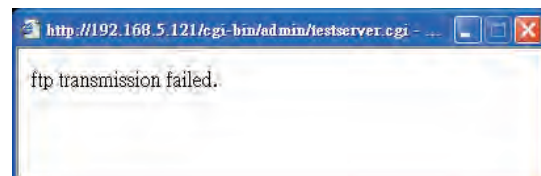
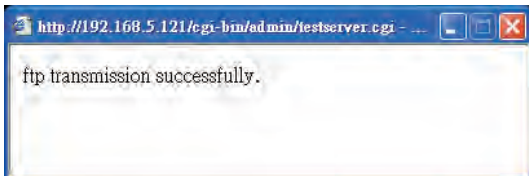

Click **Save** to enable the settings, then click **Close** to exit the page.

HTTP: Select to send the media files to an HTTP server when a trigger is activated.

Server name:

Server Type

Email:

FTP:

HTTP:

 URL:

 User name:

 Password:

Network storage:

- URL: Enter the URL of the HTTP server.
- User name: Enter the user name if necessary.
- Password: Enter the password if necessary.

To verify if the HTTP settings are correctly configured, click **Test**. The result will be shown in a pop-up window as below. If successful, you will receive a test.txt file on the HTTP server.



Click **Save** to enable the settings, then click **Close** to exit the page.

Network storage: Select to send the media files to a network storage location when a trigger is activated. Please refer to **Network Storage Setting** on page 98 for details.

Click **Save** to enable the settings, then click **Close** to exit the page.

When completed, the new server settings will automatically be displayed on the Event Settings page. For example:

	Server	Media	Extra parameter
<input type="checkbox"/>	SD	-----None-----	<input type="button" value="SD Test"/> <input type="button" value="View"/>
<input type="checkbox"/>	FTP	-----None-----	
<input type="checkbox"/>	NAS	-----None-----	<input type="checkbox"/> Create folders by date time and hour automatically <input type="button" value="View"/>
<input type="checkbox"/>	Email	-----None-----	
<input type="checkbox"/>	HTTP	-----None-----	

Media Settings

Click **Add Media** on the Event Settings page to open the Media Settings page. On this page, you can specify the type of media that will be sent when a trigger is activated. A total of 5 media settings can be configured.

Media name: Enter a name for the media setting.

Media Type

There are three choices of media types available: Snapshot, Video Clip, and System log. Select the item to display the detailed configuration options. You can configure either one or all of them.

Snapshot: Select to send snapshots when a trigger is activated.

Media Type

Snapshot

Source: Stream1

Send 1 pre-event image(s) [0~7]

Send 1 post-event image(s) [0~7]

File name prefix: Snapshot_

Add date and time suffix to file name

Video Clip

System log

Save Close

- Source: Select to take snapshots from stream 1 ~ 4.
- Send pre-event images
The Network Camera has a buffer area; it temporarily holds data up to a certain limit. Enter a number to decide how many images to capture before a trigger is activated. Up to 7 images can be generated.
- Send post-event images
Enter a number to decide how many images to capture after a trigger is activated. Up to 7 images can be generated.

For example, if both the Send pre-event images and Send post-event images are set to 7, a total of 15 images are generated after a trigger is activated.

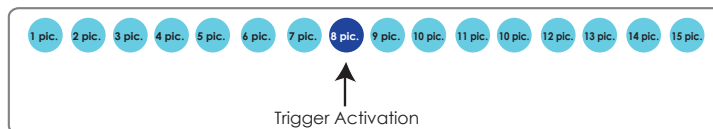

- File name prefix
Enter the text that will be appended to the front of the file name.
- Add date and time suffix to the file name
Select this option to add a date/time suffix to the file name.
For example:

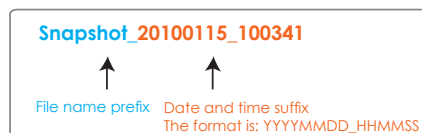

Click **Save** to enable the settings, then click **Close** to exit the page.

Video clip: Select to send video clips when a trigger is activated.

Media Type

Snapshot

Video Clip

Source:

Pre-event recording: seconds [0~9]

Maximum duration: seconds [1~10]

Maximum file size: Kbytes [50~800]

File name prefix:

System log

■ **Source**: The source of video clip, which will be identical to the time shift caching stream. For more information about time shift caching stream, please refer to page 61.

■ **Pre-event recording**

The Network Camera has a buffer area; it temporarily holds data up to a certain limit. Enter a number to decide the duration of recording before a trigger is activated. Up to 9 seconds can be set.

■ **Maximum duration**

Specify the maximum recording duration in seconds. Up to 10 seconds can be set.

For example, if pre-event recording is set to five seconds and the maximum duration is set to ten seconds, the Network Camera continues to record for another 4 seconds after a trigger is activated.

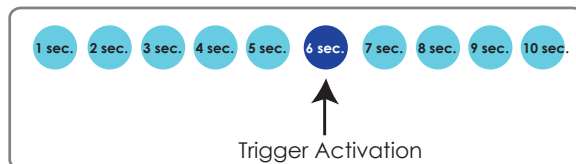

■ **Maximum file size**

Specify the maximum file size allowed.

■ **File name prefix**

Enter the text that will be appended to the front of the file name.

For example:

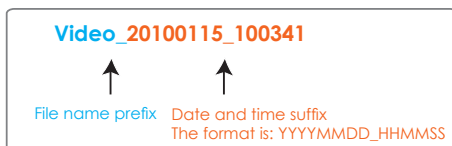

Click **Save** to enable the settings, then click **Close** to exit the page.

System log: Select to send a system log when a trigger is activated.

Click **Save** to enable the settings, then click **Close** to exit the page.

When completed, click **Save** to enable the settings and click **Close** to exit this page. The new media settings will appear on the Event Settings page.

You can continue to select a server and media type for the event. Please go back to page 91 for detailed information.

	Server	Media	Extra parameter
<input type="checkbox"/>	SD	----None----	<input type="button" value="SD Test"/> <input type="button" value="View"/>
<input type="checkbox"/>	FTP	----None---- Snapshot Video Clip System log	
<input type="checkbox"/>	NAS	----None----	<input type="checkbox"/> Create folders by date time and hour automatically <input type="button" value="View"/>
<input type="checkbox"/>	Email	----None----	
<input type="checkbox"/>	HTTP	----None----	

- **SD Test:** Click to test your SD card. The system will display a message indicating success or failure. If you want to use your SD card for local storage, please format it before use. Please refer to page 98 for detailed information.
- **Create folders by date, time, and hour automatically:** If you check this item, the system will generate folders automatically by date.
- **View:** Click this button to open a file list window. This function is only for **SD card** and **Network Storage**.

If you click **View** button of SD card, a **Local storage** page will pop up for you to manage recorded files on SD card. For more information about Local storage, please refer to page 101 for illustration.

If you click **View** button of Network storage, a **file directory window** will pop up for you to view recorded data on Network storage. For detailed illustration, please refer to the next page.

The following is an example of a file destination with video clips:

The format is: YYYYMMDD
Click to open the directory

Click to delete selected items

Click to delete all recorded data

<input type="checkbox"/>	20100115
<input type="checkbox"/>	20100116
<input type="checkbox"/>	20100117

Delete Delete all

Click [20100115](#) to open the directory:

The format is: HH (24r)
Click to open the file list for that hour

< 07 08 09 10 11 12 13 14 15 16 17 >

	file name	size	date	time
<input type="checkbox"/>	Recording1 58.mp4	2526004	2010/01/15	07:58:28
<input type="checkbox"/>	Recording1 59.mp4	2563536	2010/01/15	07:59:28

Delete Delete all Back

Click to delete selected items

Click to delete all recorded data

Click to go back to the previous level of the directory

< 07 08 09 10 11 12 13 14 15 16 17 >

	file name	size	date	time
<input type="checkbox"/>	Recording1 58.mp4	2526004	2010/01/15	07:58:28
<input type="checkbox"/>	Recording1 59.mp4	2563536	2010/01/15	07:59:28

Delete Delete all Back

The format is: File name prefix + Minute (mm)
You can set up the file name prefix on Media Settings page.
Please refer to page 94 for detailed information.

Recording Advanced Mode

This section explains how to configure the recording settings for the Network Camera.

Recording Settings

Recording Settings

Note: Before setup recording, you have to setup network storage first via [Server](#) page

Name	Status	Sun	Mon	Tue	Wed	Thu	Fri	Sat	Time	Source	Destination
Add SD Test ▼ Delete											

Insert your SD card and click here to test

NOTE

- Before setting up this page, please set up the Network Storage on the Server Settings page first.
- Please remember to format your SD card when using for the first time. Please refer to page 101 for detailed information.

Network Storage Setting

Click [Server](#) to open the Server Settings page and follow the steps below to set up:

1. Fill in the information for your server.

For example:

Server name: 3

Server Type

Email:

FTP:

HTTP:

1 Network storage:

Network storage location: 1

(For example:
\\my_nas\disk\folder)

Workgroup:

User name: 2

Password:

4

User name and password for your server

Network storage path
(\\server name or IP address\folder name)

2. Click **Test** to check the setting. The result will be shown in the pop-up window.

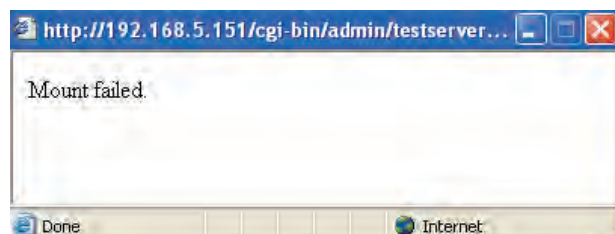
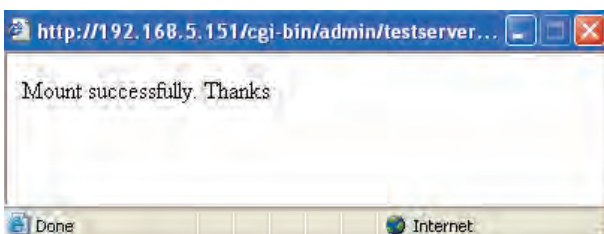

If successful, you will receive a test.txt file on the network storage server.

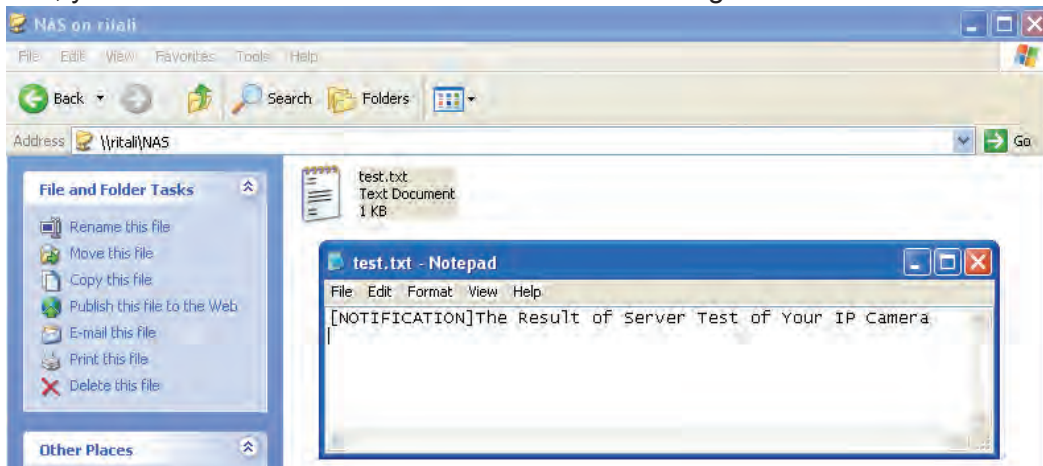

3. Enter a server name.
4. Click **Save** to complete the settings and click **Close** to exit the page.

Recording Settings

Click **Add** to open the recording setting page. In this page, you can define the recording source, recording schedule and recording capacity. A total of 2 recording settings can be configured.

Recording

Recording name:

Enable this recording

Priority:

Source:

Recording Schedule

Sun Mon Tue Wed Thu Fri Sat

Time

Always

From to [hh:mm]

Destination:

Capacity:

Entire free space

Limit recording size in Mbytes

File name prefix:

Enable cyclic recording

Reserved amount: Mbytes

Note: To enable recording notification please configure [Application](#) first

Recording name: Enter a name for the recording setting.

Enable this recording: Select this option to enable video recording.

Priority: Select the relative importance of this recording setting (High, Normal, and Low).

Source: Select the recording source (stream 1 ~ 4).

Recording Schedule: Specify the recording duration.

- Select the days of the week.
- Select the recording start and end times in 24-hr time format.

Destination: You can select the SD card or network storage that was set up for the recorded video files.

Capacity: You can choose either the entire free space available or limit the recording size. The recording size limit must be larger than the reserved amount for cyclic recording.

File name prefix: Enter the text that will be appended to the front of the file name.

Enable cyclic recording: If you check this item, when the maximum capacity is reached, the oldest file will be overwritten by the latest one. The reserved amount is reserved for cyclic recording to prevent malfunction. This value must be larger than 15 MBytes.

When completed, select **Enable this recording**. Click **Save** to enable the setting and click **Close** to exit this page. When the system begins recording, it will send the recorded files to the Network Storage. The new recording name will appear in the drop-down list on the recording page as shown below.

To remove a recording setting from the list, select a recording name from the drop-down list and click **Delete**.

Name	Status	Sun	Mon	Tue	Wed	Thu	Fri	Sat	Time	Source	Destination
Video	ON	V	V	V	V	V	V	V	00:00~24:00	stream1	NAS

Add SD Test Video Delete

- Click [Video \(Name\)](#): Opens the Recording Settings page to modify.
- Click [ON \(Status\)](#): The Status will become [OFF](#) and stop recording.
- Click [NAS \(Destination\)](#): Opens the file list of recordings as shown below. For more information about folder naming rules, please refer to page 97 for details.

<input type="checkbox"/>	20100115
<input type="checkbox"/>	20100116
<input type="checkbox"/>	20100117

Delete Delete all

Local Storage Advanced Mode

This section explains how to manage the local storage on the Network Camera. Here you can view SD card status, search for recorded files to playback, download, etc.

SD card management

- ✦ SD card status: Detached ————— no SD card
- ✦ SD card control:

Searching and viewing the records

- ✦ File attributes:
- ✦ Trigger time:

Search results

Show entries Search:

Trigger time	Media type	Trigger type	Locked
No matching records found			

Showing 0 to 0 of 0 entries

Note: "View" and "Download" only apply to the highlight item

SD Card Management

SD card status: This column shows the status and reserved space of your SD card. Please remember to format the SD card when using for the first time.

SD card management

- ✦ SD card status: Ready

Total size:	7810152 KBytes	Free size:	7602048 KBytes
Used size:	208104 KBytes	Use (%):	2.665 %

SD card control

- **Enable cyclic storage:** Check this item if you want to enable cyclic recording. When the maximum capacity is reached, the oldest file will be overwritten by the latest one.

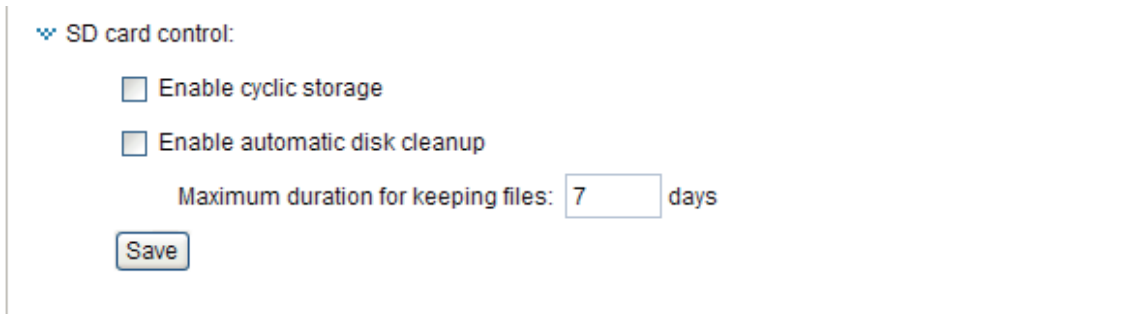

▼ SD card control:

Enable cyclic storage

Enable automatic disk cleanup

Maximum duration for keeping files: days

- **Enable automatic disk cleanup:** Check this item and enter the number of days you wish to retain a file. For example, if you enter “7 days”, the recorded files will be stored on the SD card for 7 days.

Click **Save** to enable your settings.

Searching and Viewing the Records

This column allows the user to set up search criteria for recorded data. If you do not select any criteria and click **Search** button, all recorded data will be listed in the **Search Results** column.

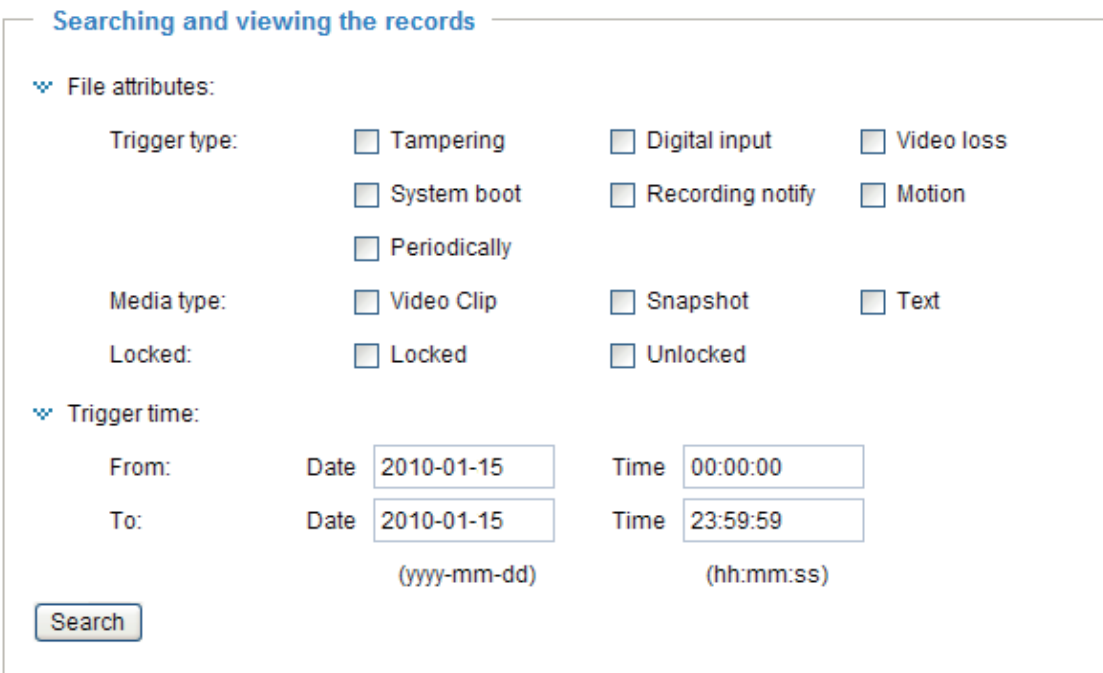

Searching and viewing the records

▼ File attributes:

Trigger type: Tampering Digital input Video loss
 System boot Recording notify Motion
 Periodically

Media type: Video Clip Snapshot Text

Locked: Locked Unlocked

▼ Trigger time:

From: Date Time
To: Date Time
(yyyy-mm-dd) (hh:mm:ss)

File attributes: Select one or more items as your search criteria.

Trigger time: Manually enter the time range you want to search.

Click **Search** and the recorded data corresponding to the search criteria will be listed in **Search Results** window.

Search Results





The following is an example of search results. There are four columns: Trigger time, Media type, Trigger type, and Locked. Click  to sort the search results in either direction.

Numbers of entries displayed on one page

Enter a key word to filter the search results

Search results

Show **10** entries Search:

<input type="checkbox"/>	Trigger time 	Media type 	Trigger type 	Locked 
<input type="checkbox"/>	2010-01-15 10:47:57	Videoclip	Periodically	No
<input type="checkbox"/>	2010-01-15 10:48:58	Videoclip	Periodically	No
<input type="checkbox"/>	2010-01-15 10:49:58	Videoclip	Periodically	No
<input type="checkbox"/>	2010-01-15 10:50:58	Videoclip	Periodically	No
<input type="checkbox"/>	2010-01-15 10:51:58	Videoclip	Periodically	No
<input type="checkbox"/>	2010-01-15 10:52:58	Videoclip	Periodically	No
<input type="checkbox"/>	2010-01-15 10:53:58	Videoclip	Periodically	No
<input type="checkbox"/>	2010-01-15 10:54:58	Videoclip	Periodically	No
<input type="checkbox"/>	2010-01-15 10:55:57	Videoclip	Periodically	No
<input type="checkbox"/>	2010-01-15 10:56:57	Videoclip	Periodically	No

Showing 11 to 20 of 32 entries

Highlight an item

Click to switch pages

Note: "View" and "Download" only apply to the highlight item

View: Click on a search result which will highlight the selected item in purple as shown above. Click the **View** button and a media window will pop up to play back the selected file. For example:

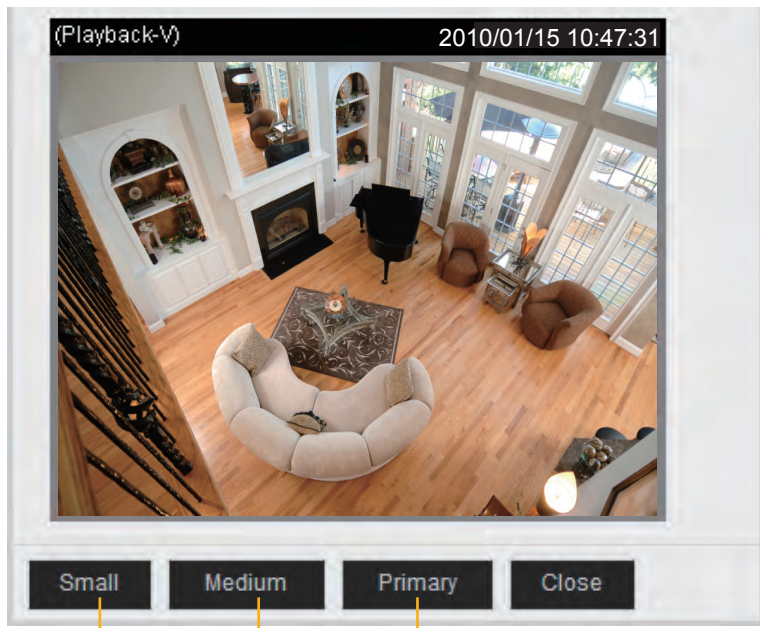

Click to adjust the image size

Download: Click on a search result to highlight the selected item in purple as shown above. Then click the **Download** button and a file download window will pop up for you to save the file.

JPEGs to AVI: This functions only applies to “JPEG” format files such as snapshots. You can select several snapshots from the list, then click this button. Those snapshots will be converted into an AVI file.

Lock/Unlock: Select the desired search results, then click this button. The selected items will become Locked, which will not be deleted during cyclic recording. You can click again to unlock the selections. For example:

The screenshot shows a 'Search results' window with a table of 10 entries. The table has columns for 'Trigger time', 'Media type', 'Trigger type', and 'Locked'. The first three rows are selected, indicated by green checkmarks in the first column and a purple background. The 'Locked' column shows 'Yes' for the selected items and 'No' for the others. Below the table, there are navigation arrows and a status bar indicating 'Showing 11 to 20 of 32 entries'. At the bottom, a toolbar contains buttons for 'View', 'Download', 'Uncheck All', 'JPEGs to AVI', 'Lock/Unlock', and 'Remove'. The 'Lock/Unlock' button is highlighted with a yellow box.

	Trigger time	Media type	Trigger type	Locked
<input checked="" type="checkbox"/>	2010-01-15 10:47:57	Videoclip	Periodically	Yes
<input checked="" type="checkbox"/>	2010-01-15 10:48:58	Videoclip	Periodically	Yes
<input checked="" type="checkbox"/>	2010-01-15 10:49:58	Videoclip	Periodically	Yes
<input type="checkbox"/>	2010-01-15 10:50:58	Videoclip	Periodically	No
<input type="checkbox"/>	2010-01-15 10:51:58	Videoclip	Periodically	No
<input type="checkbox"/>	2010-01-15 10:52:58	Videoclip	Periodically	No
<input type="checkbox"/>	2010-01-15 10:53:58	Videoclip	Periodically	No
<input type="checkbox"/>	2010-01-15 10:54:58	Videoclip	Periodically	No
<input type="checkbox"/>	2010-01-15 10:55:57	Videoclip	Periodically	No
<input type="checkbox"/>	2010-01-15 10:56:57	Videoclip	Periodically	No

Remove: Select the desired search results, then click this button to delete the files.

NOTE

- There is a limit to the number of rewrites that is possible with the SD memory card. Replacing the SD memory card when performing periodic maintenance of the camera is recommended.
- Do not use 512MB and below SD memory cards.
- The Camera system reserves approximately 60MB in SD memory cards. Any images are not recordable on this space.
- Carefully read the User’s guide, precautions on use, and any other information supplied with a purchased memory card.
- An SD memory card can be used for repeated storage. The lifespan (number of rewrites possible) of an SD memory card is greatly affected by the capacity of the SD memory card.
- Do not use a memory card containing the data recorded by another device with the camera as this may result in the camera not functioning correctly.
- Do not modify, overwrite the data, or change the folder name of an SD memory card. It may result in the camera not to function correctly.
- If you unmount or remove the SD memory card from camera, you have to turn OFF the recording status in Recording window on page 98 and Application window on page 85.

System Log Advanced Mode

This section explains how to configure the Network Camera to send the system log to the remote server as backup.

Remote Log

Remote Log

Enable remote log

Log server settings

IP address:

port:

You can configure the Network Camera to send the system log file to a remote server as a log message. When using this feature, the appropriate syslog server is required for receiving the system log message from the Network Camera.

Follow the steps below to set up the remote log:

1. In the IP address text box, enter the IP address of the remote server.
2. In the port text box, enter the port number of the remote server.
3. When completed, select **Enable remote log** and click **Save** to enable the setting.

Current Log

This column displays the system's log in chronological order. The system log is stored in the Network Camera's buffer area and will be overwritten when reaching a certain amount.

The system log messages stored in the Network Camera will be all cleared after reboot or power down the Network Camera.

View Parameters Advanced Mode

The View Parameters page lists the entire system's parameters in alphabetical order. If you need technical assistance, please provide the information listed on this page.

Maintenance

This chapter explains how to restore the Network Camera to factory default, upgrade firmware version, etc.

Reboot

Reboot

Reboot the device

This feature allows you to reboot the Network Camera, which takes about one minute to complete. When completed, the live video page will be displayed in your browser. The following message will be displayed during the reboot process.

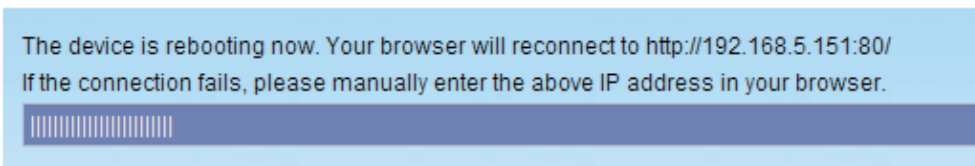

If the connection fails after rebooting, manually enter the IP address of the Network Camera in the address field to resume the connection.

Restore

Restore

Restore all settings to factory default except settings in

Network Type Daylight Saving Time Custom language

This feature allows you to restore the Network Camera to factory default settings.

Network Type: Select this option to retain the Network Type settings (please refer to Network Type on page 42).

Daylight Saving Time: Select this option to retain the Daylight Saving Time settings (please refer to System on page 33).

If none of the options is selected, all settings will be restored to factory default.

The following message is displayed during the restoring process.

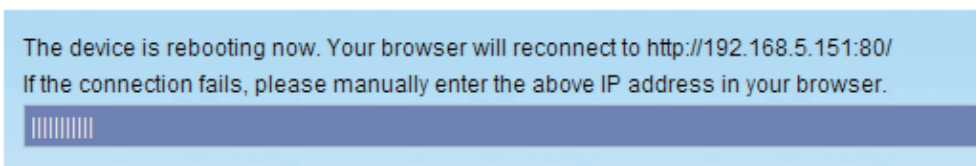

Export / Upload Files Advanced Mode

This feature allows you to Export / Upload daylight saving time rules, custom language files, and setting backup files.

Export files

Export daylight saving time configuration file	<input type="button" value="Export"/>
Export setting backup file	<input type="button" value="Export"/>

Upload files

Update daylight saving time rules	<input type="text"/>	<input type="button" value="Browse..."/>	<input type="button" value="Upload"/>
Upload setting backup file	<input type="text"/>	<input type="button" value="Browse..."/>	<input type="button" value="Upload"/>

Export daylight saving time configuration file: Click to set the start and end time of DST.

Follow the steps below to export:

1. In the Export files column, click **Export** to export the daylight saving time configuration file from the Network Camera.
2. A file download dialog will pop up as shown below. Click **Open** to review the XML file or click **Save** to store the file for editing.

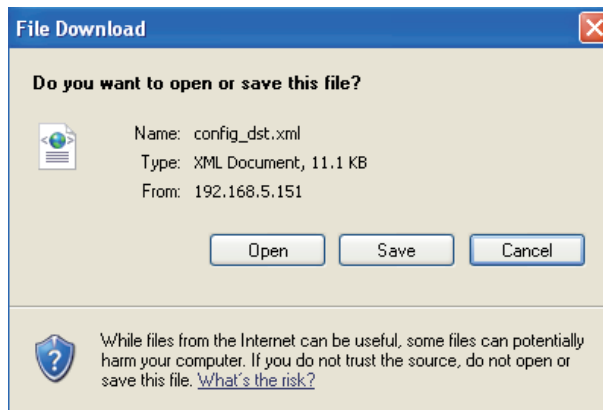

3. Open the file with a text editor and locate your time zone; set the start and end time of DST. When completed, save the file.

In the example below, DST begins each year at 2:00 a.m. on the second Sunday in March and ends at 2:00 a.m. on the first Sunday in November.

```
config_dst - Notepad
File Edit Format View Help
<Day></Day>
  <weekinMonth>First</weekinMonth>
  <DayofWeek>Sunday</DayofWeek>
  <Hour>2</Hour>
</EndTime>
</TimeZone>
<TimeZone id="-240" name="(GMT-06:00) Central Time (US and Canada)">
  <StartTime>
    <Shift>60</Shift>
    <Month>3</Month>
    <Day></Day>
    <weekinMonth>Second</weekinMonth>
    <DayofWeek>Sunday</DayofWeek>
    <Hour>2</Hour>
  </StartTime>
  <EndTime>
    <Shift>-60</Shift>
    <Month>11</Month>
    <Day></Day>
    <weekinMonth>First</weekinMonth>
    <DayofWeek>Sunday</DayofWeek>
    <Hour>2</Hour>
  </EndTime>
</TimeZone>
<TimeZone id="-241" name="(GMT-06:00) Mexico City">
```

Upload daylight saving time rule: Click **Browse...** and specify the XML file to upload.

If the incorrect date and time are assigned, you will see the following warning message when uploading the file to the Network Camera.

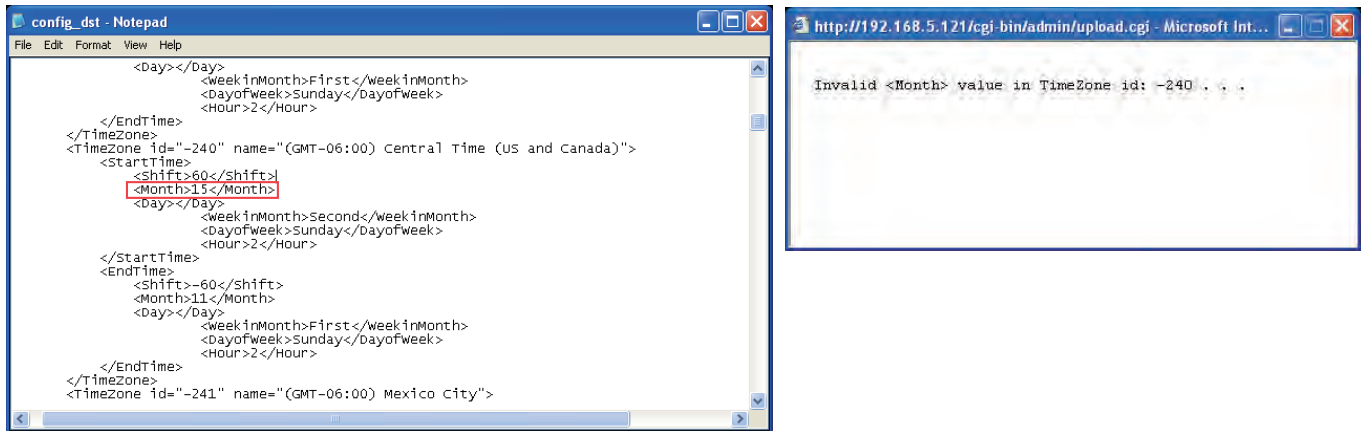

The following message is displayed when attempting to upload an incorrect file format.

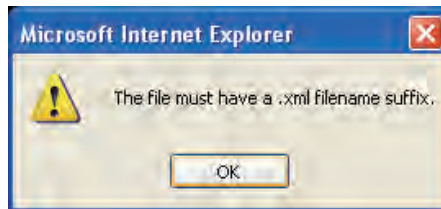

Export setting backup file: Click to export all parameters for the device and user-defined scripts.

Upload setting backup file: Click **Browse...** to upload a setting backup file. Please note that the model and firmware version of the device should be the same as the setting backup file. If you have set up a fixed IP or other special settings for your device, it is not suggested to upload a settings backup file.

Upgrade Firmware



This feature allows you to upgrade the firmware of your Network Camera. It takes a few minutes to complete the process.

Note: Do not power off the Network Camera during the upgrade!

Follow the steps below to upgrade the firmware:

1. Download the latest firmware file from the TOSHIBA website. The file is in .pkg file format.
2. Click **Browse...** and specify the firmware file.
3. Click **Upgrade**. The Network Camera starts to upgrade and will reboot automatically when the upgrade completes.

If the upgrade is successful, you will see "Reboot system now!! This connection will close". After that, re-access the Network Camera.

The following message is displayed when the upgrade has succeeded.

Reboot system now!!
This connection will close.

The following message is displayed when you have selected an incorrect firmware file.

Starting firmware upgrade...
Do not power down the server during the upgrade.
The server will restart automatically after the upgrade is completed.
This will take about 1 - 5 minutes.
Wrong PKG file format
Unpack fail



Troubleshooting

Reboot and restore

If an operational problem occurred in the camera, please refer to the Reboot and Restore function on page 16.



Restoring the factory defaults will erase any previous settings.

Audio

When using multiple network cameras, restart Internet Explorer each time you switch the camera. Using the same Internet Explorer session for the multiple cameras may transmit multiple camera's audio.

External Microphone

The usable microphone is as follows.

- Plug-in-power Condenser Microphones
- ϕ 3.5mm mini-jack

Day / Night setting

If the camera switches to night mode too early, check the light sensor. Take care not to cover the light sensor.

Recommended system requirements

Windows® XP, Windows Vista® Business, Windows 7® Professional

Internet Explorer Ver 8.0

Minimum of 2GHz CPU, 1GB RAM,
and 512MB Graphics adapter

Specifications

Power supply	12V DC \pm 10 %, PoE
Consumption current	12V DC / 0.6 A,
Image pickup device	1/3.2 inch (4:3), CMOS Digital Image Sensor
Full resolution	Horizontal 1600, vertical 1200 pixels
Scanning system	Progressive
Lens	Max. Aperture F=1:1.2 Focal length f= 3mm to 9mm
Angle of view	Wide end: horizontal 87° vertical 64° Tele end: horizontal 30° vertical 22°
Day / Night	Removable IR-Cut filter in Night mode
Minimum object illuminance	0.04 lux / F1.2 (Night mode, Max gain 4x, Exposure time 1/30)
White balance	AWB
Image size	1600x1200, 1280x960, 800x600, 640x480, 320x240, 176 x 144
Image compression system	JPEG, MPEG4
Image quality setting	6 levels
Maximum frame rate at M-JPEG*1	30 fps at 800 x 600, 15 fps at 1600 x 1200
Maximum frame rate at MPEG 4*1	30 fps at 800 x 600, 10 fps at 1600 x 1200
Digital zoom	Maximum 4 times
Microphone in / Audio out *2	MIC IN (plug-in power 3.3V, 200k Ω) / AUDIO OUT (1 Vrms)
I/O terminal	Input 1, output 1
Network interface	10Base-T / 100Base-TX, RJ45 connector, IEEE 802.3af (PoE compatible)
Protocols	TCP/IP, HTTP, UPnP, RTSP/RTP/RTCP, IGMP, SMTP, FTP, DHCP, NTP, DNS, DDNS, PPPoE, SNMP
OS	Windows [®] XP, Windows Vista [®] Business, Win 7 [®] professional
Browser	Internet Explorer [®] Ver. 8.0
Operating temperature	14°F to 122°F (-10°C to 50°C)
Operating humidity	20 % to 90 %
Weight	770 g (1.69 lbs)
Dimensions	7.13 (W) x 5.91 (D) x 4.57 (H) inches (181 (W) x 150 (D) x 116.2 (H) mm) (excluding protrusion)
Accessories	AC adapter(x1), Alignment sticker(x1), Screws(x2), Anchors(x2), I/O connector(x1), Torx driver(x1), Quick Start guide & Important Safeguards (x1), CD-ROM(User's manual and install software) (x1), Warranty Card (x1)

- Designs and specifications may change without prior notice for better improvement.
- Screens, photos, illustrations and other diagrams contained in this user's manual may slightly change from actual ones.

*1: Varies in accordance with the object, image quality, network environment and performance of the personal computer used.

*2: The sound may not be clear depending on the conditions of the lines.

Appearance Diagram

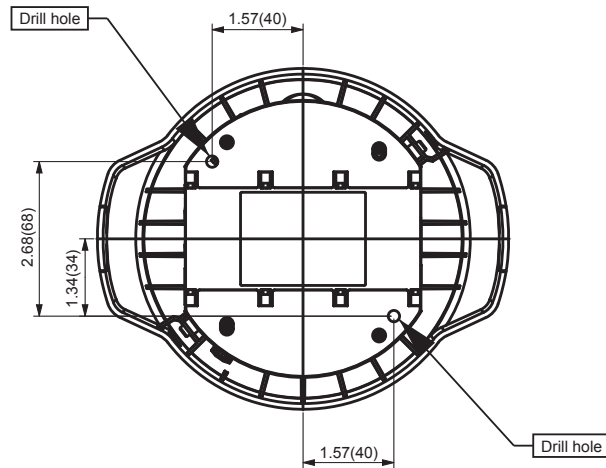
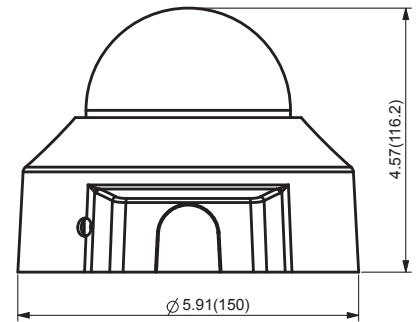
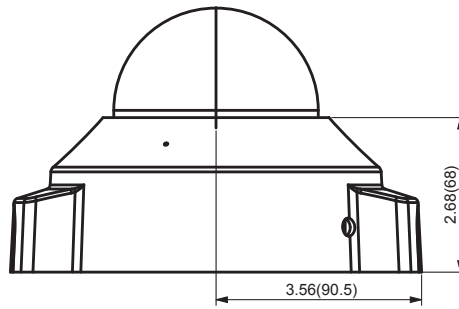
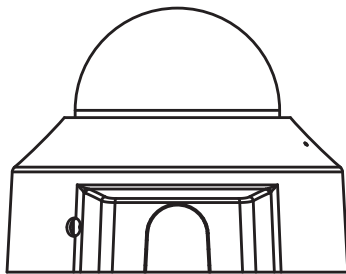
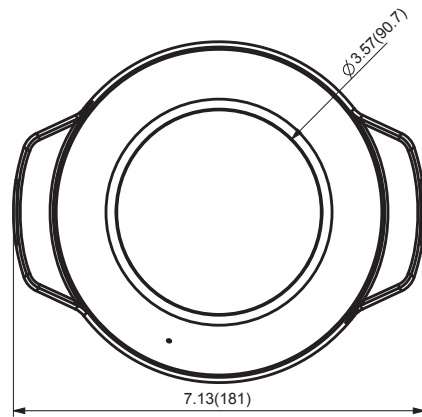

Dimensions: inch (mm)

Technology License Notice

MPEG-4 AAC Technology

THIS PRODUCT IS LICENSED UNDER THE MPEG-4 AAC AUDIO PATENT LICENSE. THIS PRODUCT MAY NOT BE DECOMPILED, REVERSE-ENGINEERED OR COPIED, EXCEPT REGARD TO PC SOFTWARE, YOU MAY MAKE SINGLE COPIES FOR ARCHIVAL PURPOSES. FOR MORE INFORMATION, PLEASE REFER TO [HTTP://WWW.VIALICENSING.COM](http://www.vialicensing.com).

MPEG-4 Visual Technology

THIS PRODUCT IS LICENSED UNDER THE MPEG-4 VISUAL PATENT PORTFOLIO LICENSE FOR THE PERSONAL AND NON-COMMERCIAL USE OF A CONSUMER FOR (i) ENCODING VIDEO IN COMPLIANCE WITH THE MPEG-4 VISUAL STANDARD ("MPEG-4 VIDEO") AND/ OR (ii) DECODING MPEG-4 VIDEO THAT WAS ENCODED BY A CONSUMER ENGAGED IN A PERSONAL AND NON-COMMERCIAL ACTIVITY AND/OR WAS OBTAINED FROM A VIDEO PROVIDER LICENSED BY MPEG LA TO PROVIDE MPEG-4 VIDEO. NO LICENSE IS GRANTED OR SHALL BE IMPLIED FOR ANY OTHER USE. ADDITIONAL INFORMATION INCLUDING THAT RELATING TO PROMOTIONAL, INTERNAL AND COMMERCIAL USES AND LICENSING MAY BE OBTAINED FROM MPEG LA, LLC. SEE [HTTP://WWW.MPEGLA.COM](http://www.mpegla.com).

AMR-NB Standard

THIS PRODUCT IS LICENSED UNDER THE AMR-NB STANDARD PATENT LICENSE AGREEMENT. WITH RESPECT TO THE USE OF THIS PRODUCT, THE FOLLOWING LICENSORS' PATENTS MAY APPLY:

TELEFONAKIEBOLAGET ERICSSON AB: US PAT. 6192335; 6275798; 6029125; 6424938; 6058359. NOKIA CORPORATION: US PAT. 5946651; 6199035. VOICEAGE CORPORATION: AT PAT. 0516621; BE PAT. 0516621; CA PAT. 2010830; CH PAT. 0516621; DE PAT. 0516621; DK PAT. 0516621; ES PAT. 0516621; FR PAT. 0516621; GB PAT. 0516621; GR PAT. 0516621; IT PAT. 0516621; LI PAT. 0516621; LU PAT. 0516621; NL PAT. 0516621; SE PAT. 0516621; US PAT. 5444816; AT PAT. 819303/AT E 198805T1; AU PAT. 697256; BE PAT. 819303; BR PAT. 9604838-7; CA PAT. 2216315; CH PAT. 819303; CN PAT. ZL96193827.7; DE PAT. 819303/DE69611607T2; DK PAT. 819303; ES PAT. 819303; EP PAT. 819303; FR PAT. 819303; GB PAT. 819303; IT PAT. 819303; JP PAT. APP. 8-529817; NL PAT. 819303; SE PAT. 819303; US PAT. 5664053. THE LIST MAY BE UPDATED FROM TIME TO TIME BY LICENSORS AND A CURRENT VERSION OF WHICH IS AVAILABLE ON LICENSOR'S WEBSITE AT [HTTP://WWW.VOICEAGE.COM](http://www.voiceage.com).

About the software

This product contains a piece of software licensed to TOSHIBA CORPORATION (hereafter TOSHIBA) by a third party. The copyright and other intellectual property rights of the software are held by this third party or the licensor. The software is protected by the Copyright Law, Universal Copyright Convention, and other intellectual property laws and agreements. The permission of Toshiba and the third party must therefore be obtained before the software can be reproduced. Contact Toshiba if you need it for more information at <http://www.toshibasecurity.com/support/firmware.jsp>.

GNU GENERAL PUBLIC LICENSE

Version 2, June 1991

Copyright (C) 1989, 1991 Free Software Foundation, Inc.

51 Franklin Street, Fifth Floor, Boston, MA 02110-1301 USA

Everyone is permitted to copy and distribute verbatim copies of this license document, but changing it is not allowed.

Preamble

The licenses for most software are designed to take away your freedom to share and change it. By contrast, the GNU General Public License is intended to guarantee your freedom to share and change free software--to make sure the software is free for all its users. This General Public License applies to most of the Free Software Foundation's software and to any other program whose authors commit to using it. (Some other Free Software Foundation software is covered by the GNU Lesser General Public License instead.) You can apply it to your programs, too.

When we speak of free software, we are referring to freedom, not price. Our General Public Licenses are designed to make sure that you have the freedom to distribute copies of free software (and charge for this service if you wish), that you receive source code or can get it if you want it, that you can change the software or use pieces of it in new free programs; and that you know you can do these things.

To protect your rights, we need to make restrictions that forbid anyone to deny you these rights or to ask you to surrender the rights. These restrictions translate to certain responsibilities for you if you distribute copies of the software, or if you modify it.

For example, if you distribute copies of such a program, whether gratis or for a fee, you must give the recipients all the rights that you have. You must make sure that they, too, receive or can get the source code. And you must show them these terms so they know their rights.

We protect your rights with two steps: (1) copyright the software, and (2) offer you this license which gives you legal permission to copy, distribute and/or modify the software.

Also, for each author's protection and ours, we want to make certain that everyone understands that there is no warranty for this free software. If the software is modified by someone else and passed on, we want its recipients to know that what they have is not the original, so that any problems introduced by others will not reflect on the original authors' reputations.

Finally, any free program is threatened constantly by software patents. We wish to avoid the danger that redistributors of a free program will individually obtain patent licenses, in effect making the program proprietary. To prevent this, we have made it clear that any patent must be licensed for everyone's free use or not licensed at all.

The precise terms and conditions for copying, distribution and modification follow.

GNU GENERAL PUBLIC LICENSE

TERMS AND CONDITIONS FOR COPYING, DISTRIBUTION AND MODIFICATION

0. This License applies to any program or other work which contains a notice placed by the copyright holder saying it may be distributed under the terms of this General Public License. The "Program", below, refers to any such program or work, and a "work based on the Program" means either the Program or any derivative work under copyright law: that is to say, a work containing the Program or a portion of it, either verbatim or with modifications and/or translated into another language. (Hereinafter, translation is included without limitation in the term "modification".) Each licensee is addressed as "you".

Activities other than copying, distribution and modification are not covered by this License; they are outside its scope. The act of running the Program is not restricted, and the output from the Program is covered only if its contents constitute a work based on the Program (independent of

having been made by running the Program). Whether that is true depends on what the Program does.

1. You may copy and distribute verbatim copies of the Program's source code as you receive it, in any medium, provided that you conspicuously and appropriately publish on each copy an appropriate copyright notice and disclaimer of warranty; keep intact all the notices that refer to this License and to the absence of any warranty; and give any other recipients of the Program a copy of this License along with the Program.

You may charge a fee for the physical act of transferring a copy, and you may at your option offer warranty protection in exchange for a fee.

2. You may modify your copy or copies of the Program or any portion of it, thus forming a work based on the Program, and copy and distribute such modifications or work under the terms of Section 1 above, provided that you also meet all of these conditions:

- a) You must cause the modified files to carry prominent notices stating that you changed the files and the date of any change.
- b) You must cause any work that you distribute or publish, that in whole or in part contains or is derived from the Program or any part thereof, to be licensed as a whole at no charge to all third parties under the terms of this License.
- c) If the modified program normally reads commands interactively when run, you must cause it, when started running for such interactive use in the most ordinary way, to print or display an announcement including an appropriate copyright notice and a notice that there is no warranty (or else, saying that you provide a warranty) and that users may redistribute the program under these conditions, and telling the user how to view a copy of this License. (Exception: if the Program itself is interactive but does not normally print such an announcement, your work based on the Program is not required to print an announcement.)

These requirements apply to the modified work as a whole. If identifiable sections of that work are not derived from the Program, and can be reasonably considered independent and separate works in themselves, then this License, and its terms, do not apply to those sections when you distribute them as separate works. But when you distribute the same sections as part of a whole which is a work based on the Program, the distribution of the whole must be on the terms of this License, whose permissions for other licensees extend to the entire whole, and thus to each and every part regardless of who wrote it.

Thus, it is not the intent of this section to claim rights or contest your rights to work written entirely by you; rather, the intent is to exercise the right to control the distribution of derivative or collective works based on the Program.

In addition, mere aggregation of another work not based on the Program with the Program (or with a work based on the Program) on a volume of a storage or distribution medium does not bring the other work under the scope of this License.

3. You may copy and distribute the Program (or a work based on it, under Section 2) in object code or executable form under the terms of Sections 1 and 2 above provided that you also do one of the following:

- a) Accompany it with the complete corresponding machine-readable source code, which must be distributed under the terms of Sections 1 and 2 above on a medium customarily used for software interchange; or,
- b) Accompany it with a written offer, valid for at least three years, to give any third party, for a charge no more than your cost of physically performing source distribution, a complete machine-readable copy of the corresponding source code, to be distributed under the terms of Sections 1 and 2 above on a medium customarily used for software interchange; or,

- c) Accompany it with the information you received as to the offer to distribute corresponding source code. (This alternative is allowed only for noncommercial distribution and only if you received the program in object code or executable form with such an offer, in accord with Subsection b above.)

The source code for a work means the preferred form of the work for making modifications to it. For an executable work, complete source code means all the source code for all modules it contains, plus any associated interface definition files, plus the scripts used to control compilation and installation of the executable. However, as a special exception, the source code distributed need not include anything that is normally distributed (in either source or binary form) with the major components (compiler, kernel, and so on) of the operating system on which the executable runs, unless that component itself accompanies the executable.

If distribution of executable or object code is made by offering access to copy from a designated place, then offering equivalent access to copy the source code from the same place counts as distribution of the source code, even though third parties are not compelled to copy the source along with the object code.

4. You may not copy, modify, sublicense, or distribute the Program except as expressly provided under this License. Any attempt otherwise to copy, modify, sublicense or distribute the Program is void, and will automatically terminate your rights under this License. However, parties who have received copies, or rights, from you under this License will not have their licenses terminated so long as such parties remain in full compliance.

5. You are not required to accept this License, since you have not signed it. However, nothing else grants you permission to modify or distribute the Program or its derivative works. These actions are prohibited by law if you do not accept this License. Therefore, by modifying or distributing the Program (or any work based on the Program), you indicate your acceptance of this License to do so, and all its terms and conditions for copying, distributing or modifying the Program or works based on it.

6. Each time you redistribute the Program (or any work based on the Program), the recipient automatically receives a license from the original licensor to copy, distribute or modify the Program subject to these terms and conditions. You may not impose any further restrictions on the recipients' exercise of the rights granted herein. You are not responsible for enforcing compliance by third parties to this License.

7. If, as a consequence of a court judgment or allegation of patent infringement or for any other reason (not limited to patent issues), conditions are imposed on you (whether by court order, agreement or otherwise) that contradict the conditions of this License, they do not excuse you from the conditions of this License. If you cannot distribute so as to satisfy simultaneously your obligations under this License and any other pertinent obligations, then as a consequence you may not distribute the Program at all. For example, if a patent license would not permit royalty-free redistribution of the Program by all those who receive copies directly or indirectly through you, then the only way you could satisfy both it and this License would be to refrain entirely from distribution of the Program.

If any portion of this section is held invalid or unenforceable under any particular circumstance, the balance of the section is intended to apply and the section as a whole is intended to apply in other circumstances.

It is not the purpose of this section to induce you to infringe any patents or other property right claims or to contest validity of any such claims; this section has the sole purpose of protecting the integrity of the free software distribution system, which is implemented by public license practices. Many people have made generous contributions to the wide range of software distributed through that system in reliance on consistent application of that system; it is up to the author/donor to decide if he or she is willing to distribute software through any other system and

a licensee cannot impose that choice.

This section is intended to make thoroughly clear what is believed to be a consequence of the rest of this License.

8. If the distribution and/or use of the Program is restricted in certain countries either by patents or by copyrighted interfaces, the original copyright holder who places the Program under this License may add an explicit geographical distribution limitation excluding those countries, so that distribution is permitted only in or among countries not thus excluded. In such case, this License incorporates the limitation as if written in the body of this License.

9. The Free Software Foundation may publish revised and/or new versions of the General Public License from time to time. Such new versions will be similar in spirit to the present version, but may differ in detail to address new problems or concerns.

Each version is given a distinguishing version number. If the Program specifies a version number of this License which applies to it and "any later version", you have the option of following the terms and conditions either of that version or of any later version published by the Free Software Foundation. If the Program does not specify a version number of this License, you may choose any version ever published by the Free Software Foundation.

10. If you wish to incorporate parts of the Program into other free programs whose distribution conditions are different, write to the author to ask for permission. For software which is copyrighted by the Free Software Foundation, write to the Free Software Foundation; we sometimes make exceptions for this. Our decision will be guided by the two goals of preserving the free status of all derivatives of our free software and of promoting the sharing and reuse of software generally.

NO WARRANTY

11. BECAUSE THE PROGRAM IS LICENSED FREE OF CHARGE, THERE IS NO WARRANTY FOR THE PROGRAM, TO THE EXTENT PERMITTED BY APPLICABLE LAW. EXCEPT WHEN OTHERWISE STATED IN WRITING THE COPYRIGHT HOLDERS AND/OR OTHER PARTIES PROVIDE THE PROGRAM "AS IS" WITHOUT WARRANTY OF ANY KIND, EITHER EXPRESSED OR IMPLIED, INCLUDING, BUT NOT LIMITED TO, THE IMPLIED WARRANTIES OF MERCHANTABILITY AND FITNESS FOR A PARTICULAR PURPOSE. THE ENTIRE RISK AS TO THE QUALITY AND PERFORMANCE OF THE PROGRAM IS WITH YOU. SHOULD THE PROGRAM PROVE DEFECTIVE, YOU ASSUME THE COST OF ALL NECESSARY SERVICING, REPAIR OR CORRECTION.

12. IN NO EVENT UNLESS REQUIRED BY APPLICABLE LAW OR AGREED TO IN WRITING WILL ANY COPYRIGHT HOLDER, OR ANY OTHER PARTY WHO MAY MODIFY AND/OR REDISTRIBUTE THE PROGRAM AS PERMITTED ABOVE, BE LIABLE TO YOU FOR DAMAGES, INCLUDING ANY GENERAL, SPECIAL, INCIDENTAL OR CONSEQUENTIAL DAMAGES ARISING OUT OF THE USE OR INABILITY TO USE THE PROGRAM (INCLUDING BUT NOT LIMITED TO LOSS OF DATA OR DATA BEING RENDERED INACCURATE OR LOSSES SUSTAINED BY YOU OR THIRD PARTIES OR A FAILURE OF THE PROGRAM TO OPERATE WITH ANY OTHER PROGRAMS), EVEN IF SUCH HOLDER OR OTHER PARTY HAS BEEN ADVISED OF THE POSSIBILITY OF SUCH DAMAGES.

END OF TERMS AND CONDITIONS

How to Apply These Terms to Your New Programs

If you develop a new program, and you want it to be of the greatest possible use to the public, the best way to achieve this is to make it free software which everyone can redistribute and change under these terms.

To do so, attach the following notices to the program. It is safest to attach them to the start of each source file to most effectively convey the exclusion of warranty; and each file should have at least the "copyright" line and a pointer to where the full notice is found.

<one line to give the program's name and a brief idea of what it does.>

Copyright (C) <year> <name of author>

This program is free software; you can redistribute it and/or modify it under the terms of the GNU General Public License as published by the Free Software Foundation; either version 2 of the License, or (at your option) any later version.

This program is distributed in the hope that it will be useful, but WITHOUT ANY WARRANTY; without even the implied warranty of MERCHANTABILITY or FITNESS FOR A PARTICULAR PURPOSE. See the GNU General Public License for more details.

You should have received a copy of the GNU General Public License along with this program; if not, write to the Free Software Foundation, Inc., 51 Franklin Street, Fifth Floor, Boston, MA 02110-1301 USA

Also add information on how to contact you by electronic and paper mail.

If the program is interactive, make it output a short notice like this when it starts in an interactive mode:

Gnomovision version 69, Copyright (C) year name of author

Gnomovision comes with ABSOLUTELY NO WARRANTY; for details type `show w'.

This is free software, and you are welcome to redistribute it under certain conditions; type `show c' for details.

The hypothetical commands `show w' and `show c' should show the appropriate parts of the General Public License. Of course, the commands you use may be called something other than `show w' and `show c'; they could even be mouse-clicks or menu items--whatever suits your program.

You should also get your employer (if you work as a programmer) or your school, if any, to sign a "copyright disclaimer" for the program, if necessary. Here is a sample; alter the names:

Yoyodyne, Inc., hereby disclaims all copyright interest in the program `Gnomovision' (which makes passes at compilers) written by James Hacker.

<signature of Ty Coon>, 1 April 1989

Ty Coon, President of Vice

This General Public License does not permit incorporating your program into proprietary programs. If your program is a subroutine library, you may consider it more useful to permit linking proprietary applications with the library. If this is what you want to do, use the GNU Lesser General Public License instead of this License.

TOSHIBA AMERICA INFORMATION SYSTEMS, INC.

Surveillance & IP Video Products

9740 Irvine Boulevard,

Irvine, CA 92618-1697

Phone Number: (877) 855-1349