

**STOP!**  
**BEFORE INSTALLING OR CONNECTING IK-WB21A TO YOUR PC, READ THIS QUICK GUIDE**

## TOSHIBA Network Camera IK-WB21A Quick Guide

### Connect the network camera to your personal computer.

- Connection example (Connecting to a personal computer by a LAN cable through a hub or a router)

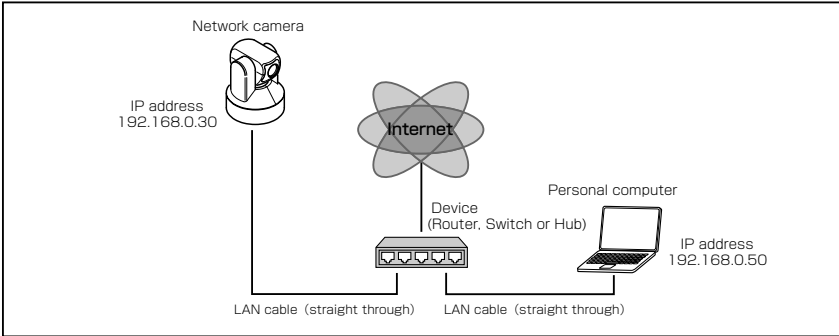

#### **NOTE**

- When connecting via device, the network segment must be the same network segment.

### Obtaining IP address

- Obtaining from DHCP server  
IP address is automatically obtained by default. Just connect to the network if you will connect to a network that uses the DHCP server. No other setting is required.  
\* If the DHCP server is not used, your network camera will be automatically assigned to the fixed IP address "192.168.0.30."

### "Camera Finder"

- Searching the camera by "Camera Finder"
- Install Camera Finder from the CD-ROM supplied as an accessory.
- Select "Start" - "Program" - "TOSHIBA Network Camera" - "Camera Finder."
- Click the "Search" button.
- Click the desired camera in the search list to log in the searched camera.
- Click the "Administrator" button.  
Your browser will be booted and the "Camera Window" screen will appear.  
When booting "Camera Window" for the first time, ActiveX control will be downloaded automatically from the product. A confirmation dialog box may or may not appear on the screen. Click "Yes" if it appears.

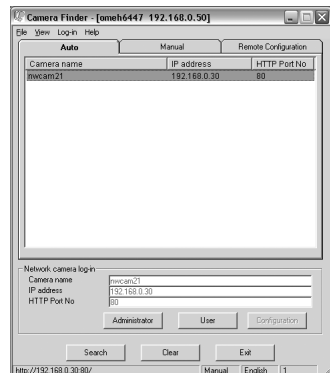

# TOSHIBA Network Camera IK-WB21A Quick Guide (Cont.)

## Logging in

- Enter "root" in the User Name text box and "ikwb" in the password text box.
- Click "OK."



## Changing the login name and password

Administrator login allows changing important informations such as camera settings. Be sure to change the user name and password to ensure camera security.

### Administrator information setting

- Select "Administrator function" / "ID password change" on the Admin. Menu.
- Enter the desired ID and password in the Administrator ID text box and Administrator Password text box respectively.
- Click "Save."

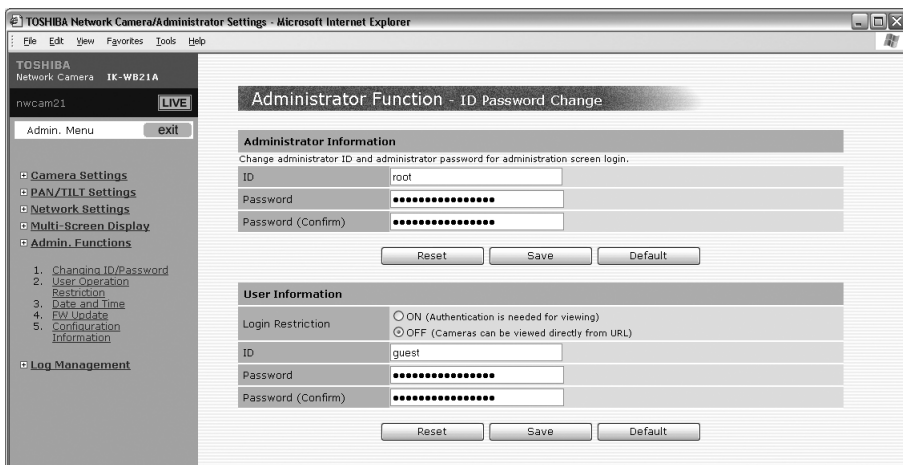

### User information setting

- Set "ON" or "OFF" for "Login Restriction."
- Enter the desired ID and password in the User ID text box and User Password text box respectively.
- Click "Save."

# Setup Screen

Camera name

**LIVE** button

Displays the camera image screen.

**exit** button

Closes the Setting screen.

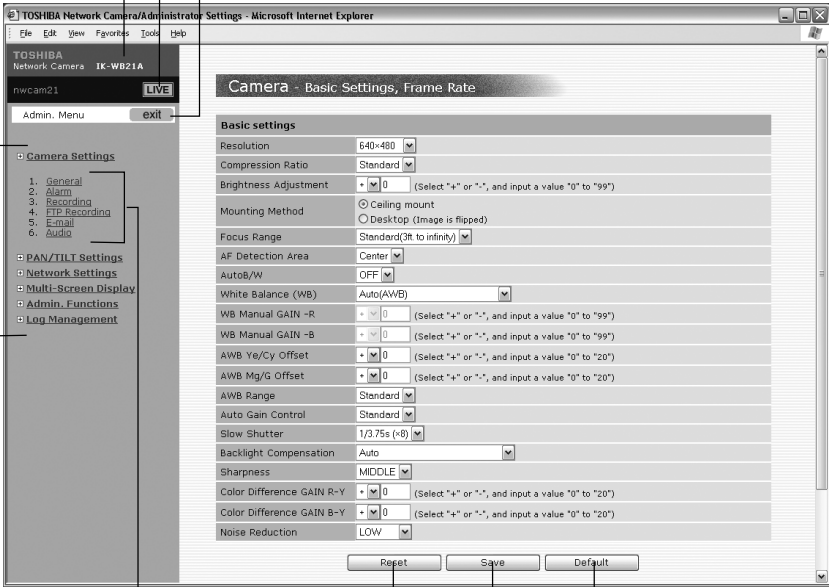

Main Menu

Sub Menu

**"Reset"** button

Resets to condition before change

**"Default"** button

Resets settings back to factory default.

**"Save"** button









Saves changes

# TOSHIBA Network Camera IK-WB21A Quick Guide (Cont.)

## Setup Screen



Number and Item	Description
① Camera name	The name of the camera displaying live images.
② Operation Buttons	<p> : Clicking the  button will zoom out.</p> <p> : Each clicking of the  button will zoom in on the image. Can be zoomed in 22x at maximum..</p> <p> : Each click of the  button will adjust the near focus.</p> <p> : Clicking the  button will set auto focusing.</p> <p> : Each click of the  button will adjust the far focus.</p> <p> : Clicking the  button will change the display to the  button and will output sound.</p> <p>Clicking the  button will change the display to the  button and will not output sound.</p> <p> : Clicking the  button will change the display to the  button and will output sound from the personal computer microphone.</p> <p>Clicking the  button will change the display to the  button and will not output sound from the personal computer microphone.</p>
③ Operation Buttons	<p> : Equal size button. Click  to reset to a viewer size according to the resolution.</p>

Number and Item	Description
④ Screen changeover	Clicking the  button automatically displays a multi-view screen with split frames in accordance with the number of cameras set in Multi Screen setting (see page 90). Click the  button to return to the single-view screen. A multi-view screen will not be displayed if the Multi Screen Display function (see page 90) is set to OFF.
⑤ Display controller 	Clicking the  button displays the controller in a separate window.
⑥ Setup Menu Display 	Clicking the  button will display the Setup Menu screen in other window.
⑦ Alarm notification 	This is displayed when "Motion Detection" ( page 74) or "Alarm In" (page 74) is activated. The  disappears if it is clicked.
⑧ Displayed images	When displaying present normal images, "LIVE" will be displayed, and when displaying images from the Alarm List or Record List, "PLAYBACK" will be displayed on the screen. You can switch these views using the controller.
⑨ Time and date	The current time and date of the network camera are shown when "LIVE" is displayed, and the recorded time and date* are shown when "PLAYBACK" is displayed on the screen. When in PLAYBACK mode, S) or E) may be shown with the time and date. "S)" and "E)" are sometimes displayed in the PLAYBACK mode as date and time data. "S)" means start of playback images and "E)," end of playback images. In these modes, images or date and time cannot be updated. Operate playback on the controller.

■ Moving the screen center.

- 1 Click on any area in the Camera Image screen.
- 2 The camera moves so that the clicked point becomes the center of the image.

# TOSHIBA Network Camera IK-WB21A Quick Guide (Cont.)



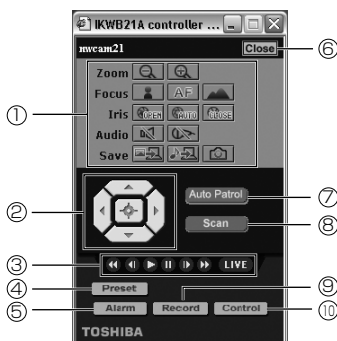















## Controller



### ● Functions of components of Administrator basic controller



Number and Item	Description
① Operation Buttons	
Zoom	: Zoom out button. Click to zoom out. : Zoom in button. Click to zoom in.
Focus	: Near button. For manual adjustment of the focus. Focuses on a near object. : Auto focus button. Clicking changes to auto focus operation. If Manual mode is set at present, focusing will be performed automatically. The Auto Focus mode will then set. If the Auto Focus mode is set at present, refocus. : Far button. Focusing is manually adjusted. Focuses on a far object.
Iris	: Iris open button. Manually adjusts the lens iris. Opens the aperture. (Becomes bright) : Iris auto button. Sets the aperture to the auto mode. : Iris close button. Manually adjusts the lens iris. Closes the aperture. (Becomes dark)
Audio	: Audio input button. Plays sound that is input to the camera. : Audio output button. Transfers sound that is input to the personal computer microphone to the camera.
Save	: Image record button. Continually records images. : Audio record button. Continually records audio input. : One-shot button. Records one image.

● Functions of components of Administrator basic controller

Number and Item	Description
<p>② Controller</p> 	<p>This feature adjusts the direction of the lens by panning (left/right) and tilting (up/down).</p> <ol style="list-style-type: none"> <li>1. Each time you click the  button, the lens moves up. You can move the lens in a range of four different vertical positions. When the camera lens reaches its upper limit, clicking on the button has no effect.</li> <li>2. Each time you click the  button, the lens moves left. You can move the lens in a range of four different horizontal positions. When the camera lens reaches its left most limit, clicking on the button has no effect.</li> <li>3. Each time you click the  button, the lens moves down. You can move the lens in a range of four different vertical positions. When the camera lens reaches its lower limit, clicking on the button has no effect.</li> <li>4. Each time you click the  button, the lens moves right. You can move the lens in a range of four different horizontal positions. When the camera lens reaches its right most limit, clicking on the button has no effect.</li> <li>5. Clicking the  button returns the lens to its center position. If an external impact or other force moves the lens from its preset position, click this button to correct the position.</li> </ol>
<p>③ Control buttons for playing and recording</p>       	<p>Fast rewinds play images. When "S" is indicated in date and time display, recorded images have been rewound to the first image.</p> <p> Play images are played frame by frame in reverse direction.</p> <p> Plays images being selected.</p> <p> Pauses an image being played.</p> <p> Play images are played frame by frame.</p> <p>Fast rewinds play images. When "E" is indicated in date and time display, recorded images have been fed to the last image.</p> <p> Resets the play image mode to the current image mode.</p>
<p>④ <b>Presets</b></p>	<p>The Preset button. The preset control panel will appear.</p>
<p>⑤ <b>Alarm</b></p>	<p>The Alarm List button. The list of "Alarm In" will appear.</p>
<p>⑥ <b>Close</b></p>	<p>The Close button. Exits the controller screen.</p>

# TOSHIBA Network Camera IK-WB21A Quick Guide (Cont.)

- Functions of components of Administrator basic controller

Number and Item	Description
⑦ <b>Auto Patrol</b>	The Auto Patrol feature moves the lens automatically to all the configured preset positions in order. Clicking the <b>Auto Patrol</b> button starts Auto Patrol. Clicking one of  buttons stops the action.
⑧ <b>Scan</b>	The Scan feature automatically moves (swivels) the lens horizontally back and forth once. Clicking the <b>Scan</b> button starts Scan. Clicking one of  buttons stops the action.
⑨ <b>Record</b>	"Continuous Recording" button. The list of "Continuous Recording" will appear.
⑩ <b>Control</b>	"EXT. Control In" button. The list of "EXT. Control In" will appear.

## NOTE

- Setting the Manual mode adjusts brightness only by the lens aperture.
- Zooming, PAN/TILT operation or moving to the screen center during manual focus adjustment automatically sets the Auto Focus mode.
- The value immediately before operation of the auto panning function will be maintained as the focus value during operation of the auto panning function. The Auto Focus mode will set after operation completes.
- A picture displayed by the  button (one-shot button) should be saved using "Save Picture As..." with a mouse right button. However, depending on installation (Ceiling/Desktop) and its settings, the picture may be carrying out vertical reversal.

## TOSHIBA AMERICA INFORMATION SYSTEMS, INC.

Security & Network Video Products

9740 Irvine Boulevard,

Irvine California 92618-1697

Phone Number: (877)696-3822